

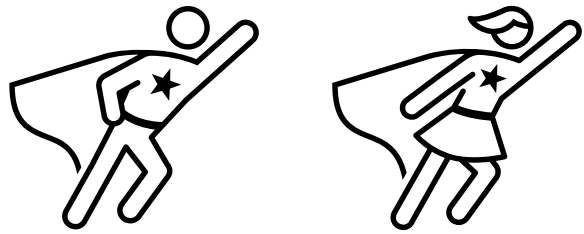

“The rise of the citizen developer”
in process automation

05 Mai 2022





**The Rise
of the
Citizen Developer**

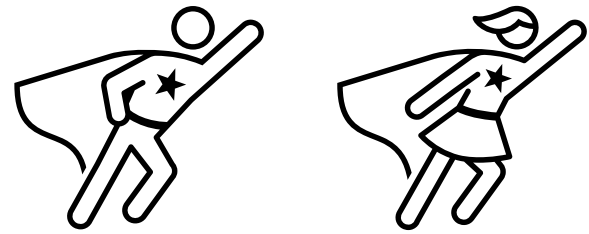

The Rise of the Citizen Developer

citizen developer



citizen developer



citizen developer × 🔍

[🔍 Alle](#) [📰 News](#) [🖼️ Bilder](#) [📺 Videos](#) [🛒 Shopping](#) [⋮ Mehr](#) Suchfilter

Ungefähr 144.000.000 Ergebnisse (0,47 Sekunden)

<https://www.google.com/search?q=citizen+developer>

30.04.2022



citizen developer



citizen developer × 🔍

[🔍 Alle](#) [📰 News](#) [🖼️ Bilder](#) [📺 Videos](#) [🛒 Shopping](#) [⋮ Mehr](#) Suchfilter

Ungefähr 144.000.000 Ergebnisse (0,47 Sekunden)

<https://www.google.com/search?q=citizen+developer>

30.04.2022

 citizen developer × 🔍

[🔍 Alle](#) [📰 News](#) [🖼️ Bilder](#) [📺 Videos](#) [🛒 Shopping](#) [⋮ Mehr](#) Suchfilter

Ungefähr 46.300.000 Ergebnisse (0,43 Sekunden)

<https://www.google.com/search?q=citizen+developer>

30.11.2021



citizen developer



citizen developer

Alle News Bilder Videos Shopping Mehr Suchfilter

Ungefähr **144.000.000** Ergebnisse (0,47 Sekunden)

<https://www.google.com/search?q=citizen+developer>

30.04.2022

Google citizen developer

Alle News Bilder Videos Shopping Mehr Suchfilter

Ungefähr **46.300.000** Ergebnisse (0,43 Sekunden)

<https://www.google.com/search?q=citizen+developer>

30.11.2021



Citizen developers are rapidly becoming the vanguard of corporate digitisation

<https://www.economist.com/business/2022/01/29/what-if-all-workers-wrote-software-not-just-the-geek-elite>

Citizen developers are taking on more of the heavy lifting of enterprise applications

<https://www.zdnet.com/article/citizen-developers-are-taking-on-more-of-the-heavy-lifting-of-enterprise-applications/>

Gartner Research

Citizen Development Is Fundamental to Digital Transformation

<https://www.gartner.com/en/documents/3815964>

The world population of citizen developers isn't massive — just a few tens of millions, according to The Economist — but it's growing at a blistering 40% year-over-year. That's three times faster than the population of developers (25M) is growing.

<https://www.economist.com/business/2022/01/29/what-if-all-workers-wrote-software-not-just-the-geek-elite>





Introducing PMI Citizen Developer™

Learn how to unlock the potential of citizen development in your organization.

<https://www.pmi.org/citizen-developer>





THE IT SKILLS GAP

RISE OF THE CITIZEN DEVELOPER

- Almost 80% of leading companies (pacesetters) use citizen developers.

Citizen Developers Can Use **Low Code Software**

<https://www.alphasoftware.com/blog/citizen-developer>

Low Code und No Code: Citizen Development Enabler

<https://www.computerwoche.de/a/softwareentwicklung-als-self-service,3551849>

Low-code is more collaborative, faster and cheaper than traditional development

<https://www.mendix.com/press/low-code-achieves-mainstream-status-according-to-new-ground-breaking-research/>

The global low code development platform market was valued at USD 10.82 billion in 2020. The market is projected to grow from USD 13.89 billion in 2021 to **USD 94.75 billion by 2028** at a CAGR of 31.6% during the forecast period. The

<https://www.economist.com/business/2022/01/29/what-if-all-workers-wrote-software-not-just-the-geek-elite>



Low-Code wieder im Trend

Emerging Technologies and Trends Impact Radar

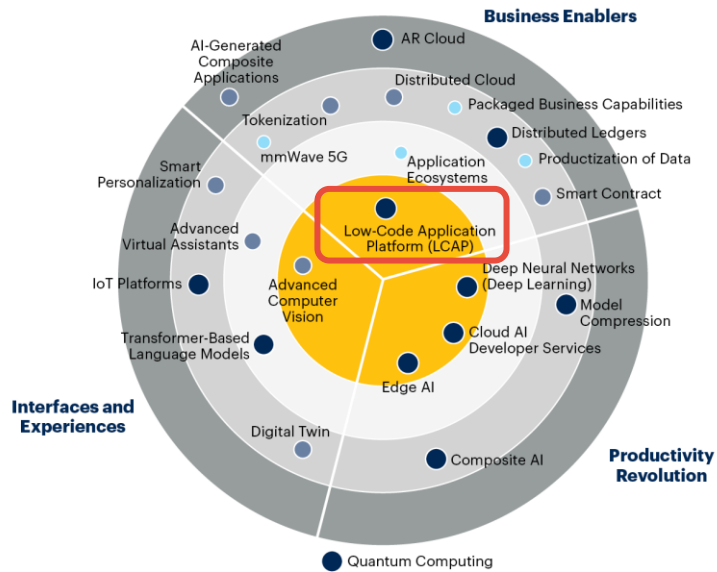

Mass
 ● Low
 ● Medium
 ● High
 ● Very High

Range
 ■ 6 to 8 Years
 ■ 3 to 6 Years
 ■ 1 to 3 Years
 ■ Now (0 to 1 Year)

[gartner.com/SmarterWithGartner](https://www.gartner.com/SmarterWithGartner)

Source: Gartner
 © 2021 Gartner, Inc. All rights reserved. CTMKT_1151750



Low-Code wieder im Trend

Experienced Low Code Developers Value Request Handling and Business Process Management More Than Others

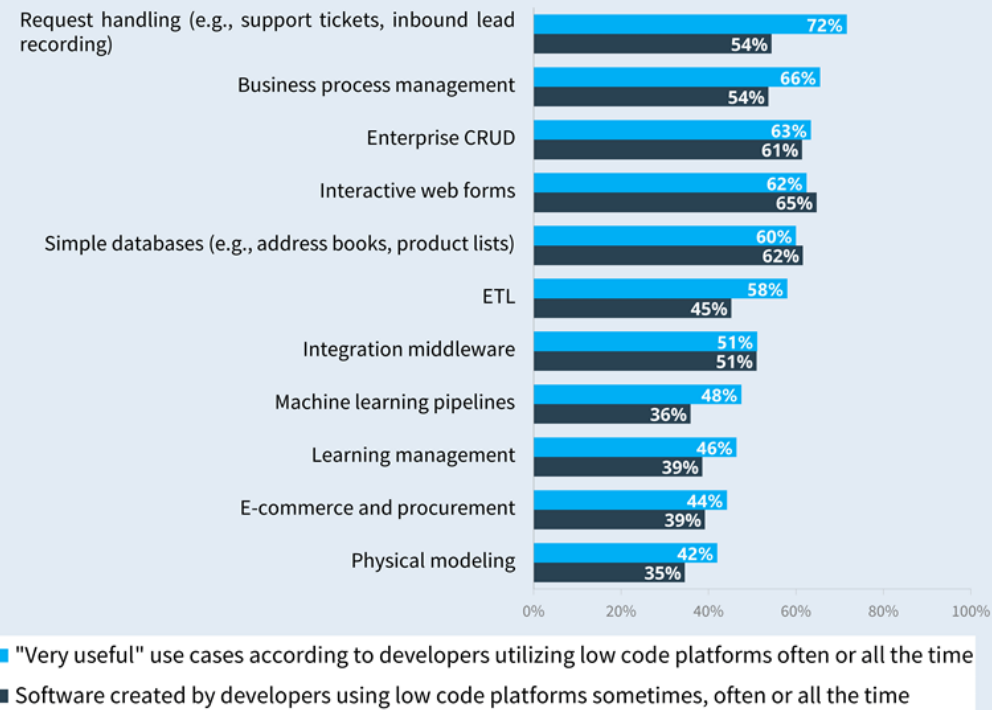

Source: DZone's Low-Code Development trends report. August 2021. In your opinion, what use cases are low-code platforms useful for? What kind(s) of software have you created using a low-code platform? n=553

@ 2021 THE NEW STACK



Low-Code wieder im Trend

based on a survey of 2,025 IT professionals across six countries. The findings reveal that 77% of enterprises in six countries have already adopted low-code, and 75% of IT leaders said it's a trend they can't afford to miss.

needs. Although those pressures appear to suggest that IT professionals are worried about digital disruption, the Mendix report shows that 58% of IT are actually excited by the acceleration. For 45%, acceleration in IT has brought an urgency for faster and more collaborative development.

development cannot meet the growing demand. The research findings illustrate the trend:

- 76% of IT professionals surveyed said the demand for developers has reached a fever pitch
- The cost of software development is rising, according to 61% of organizations
- Two-thirds of software projects are being delivered behind schedule
- Despite working tirelessly, 62% of organizations are finding their backlog increasing

<https://www.mendix.com/resources/the-state-of-low-code-report/>





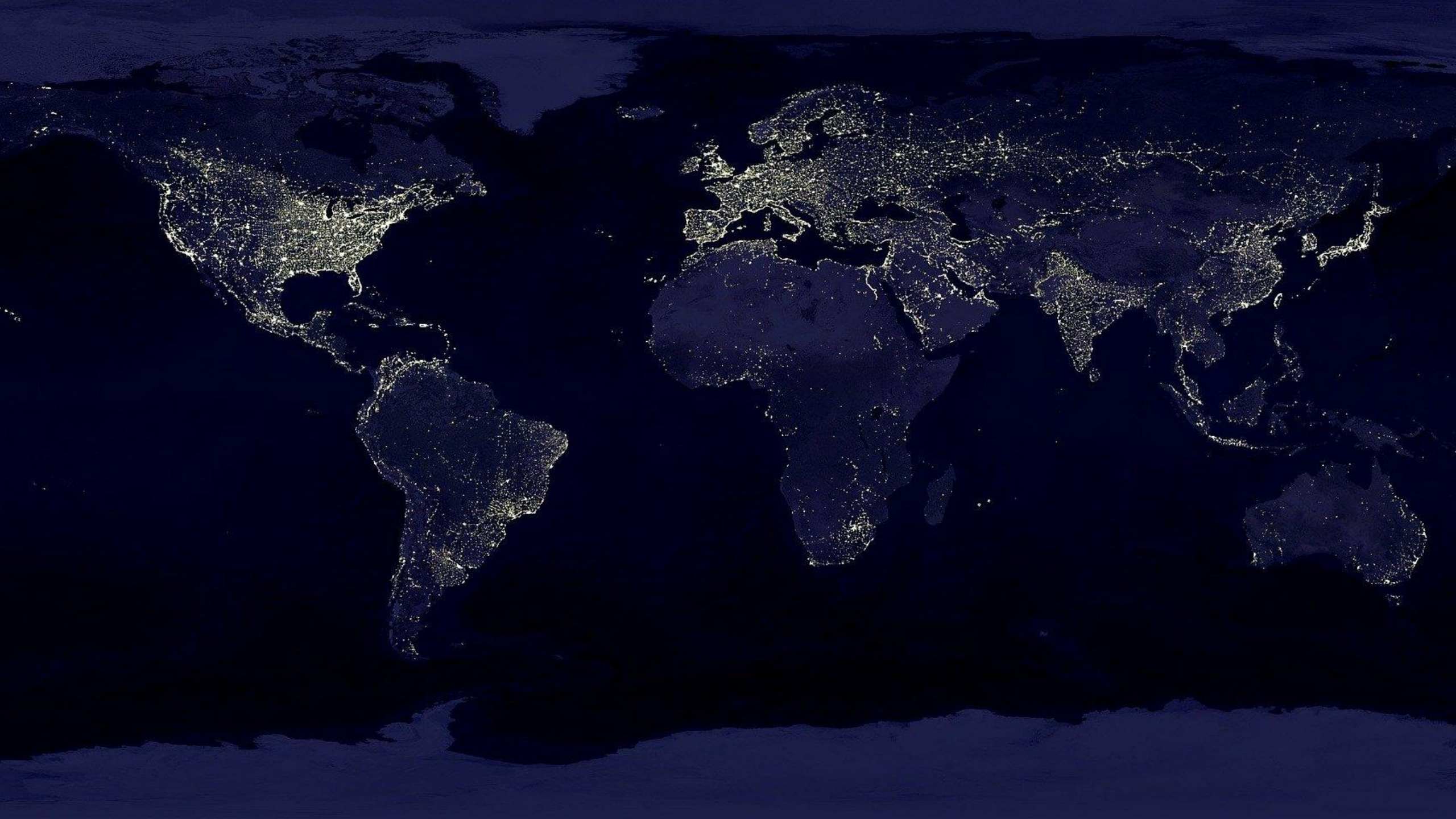

Citizen Developer bei uns ?



Immer mehr Fachabteilungen wollen unabhängig von der zentralen IT eigene Anwendungen entwickeln. Das sogenannte Citizen Development macht's möglich.

<https://www.cio.de/a/fachbereiche-emanzipieren-sich-von-der-it,3671061>

Citizen Developer und Self-Service-Portale können die Softwareentwicklung agiler und innovativer gestalten. Lesen Sie, wie.

<https://www.computerwoche.de/a/softwareentwicklung-als-self-service,3551849>

Die Vision des Citizen Development lautet, dass Angestellte aus Fachabteilungen ihre eigenen Werkzeuge zur Digitalisierung ihrer Arbeit herstellen.

<https://www.cio.de/a/fachbereiche-emanzipieren-sich-von-der-it,3671061>

Citizen Development im Aufwind

<https://www.computerwoche.de/a/was-ist-ein-citizen-developer,3550357>

Digitalisierungstrend 2022: Citizen-assisted Development unterstützt agile Unternehmensstrukturen

<https://de.eas-mag.digital/citizen-assisted-development-unterstuetzt-agile-unternehmensstrukturen/>

Kaum ein Unternehmen wird in Zukunft ohne Citizen Developer auskommen

<https://www.mimacom.com/blog/kaum-ein-unternehmen-wird-in-zukunft-ohne-citizen-developer-auskommen/>



Digitale Transformation dank Citizen Development

Mit Low-Code wider den Fachkräftemangel

Der Fachkräftemangel hat jedoch auch die IT-Branche fest im Griff: 2021 blieben [laut einer Bitkom-Studie ganze 96.000 Stellen unbesetzt](#). Und professionelle Code-Experten bleiben auch in den nächsten Jahren eine Rarität, prognostiziert der Bitkom Verband.

Unternehmen, die sich digital aufstellen wollen und eigene Apps entwickeln, brauchen also andere Lösungen – das Gebot der Stunde lautet [Low-Code](#).

<https://www.dev-insider.de/mit-low-code-wider-den-fachkraeftemangel-a-1107062/>



Citizen Developer als mögliche Lösung

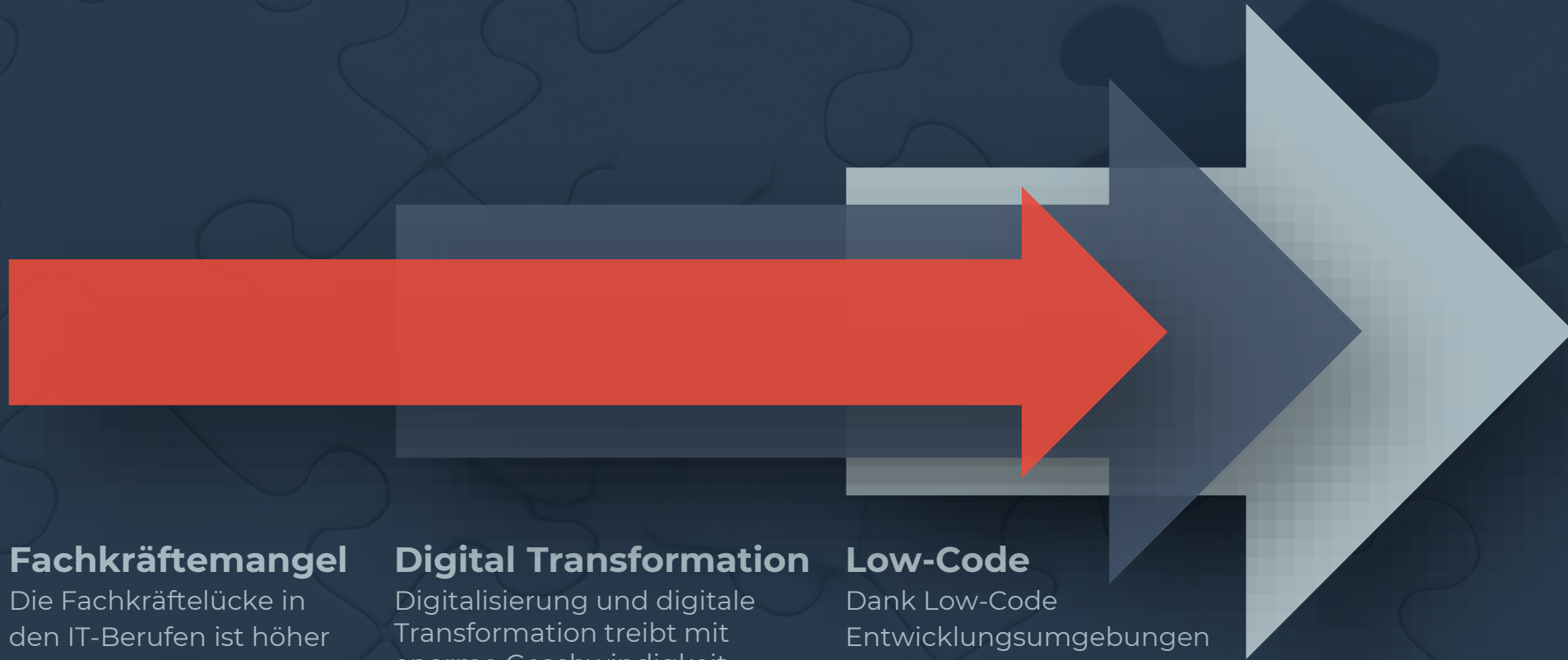

Fachkräftemangel

Die Fachkräftelücke in den IT-Berufen ist höher als je früher.

Digital Transformation

Digitalisierung und digitale Transformation treibt mit enorme Geschwindigkeit neue Lösungen.

Low-Code

Dank Low-Code Entwicklungsumgebungen schneller ans Ziel kommen.

Citizen developer

Anzahl der neuer Citizen Developer wächst dreimal schneller als Anzahl neuer IT-Experten



Was ist ein Citizen Developer?

Citizen Developer - Definition

Citizen Developer bedeutet so viel wie "Fachbereichsentwickler" und beschreibt technisch versierte Mitarbeiter, die softwarebasierte Anwendungen für ihren jeweiligen Fachbereich erstellen. Zu diesem Zweck wird ihnen von der Unternehmens-IT eine standardisierte Entwicklungsumgebung bereitgestellt - **Low-Code-Plattformen** fallen hier oftmals in die engere Wahl.

<https://www.cio.de/a/was-ist-ein-citizen-developer,3550357>



Was ist ein Citizen Developer?

Citizen Developer - Definition

Citizen Developer bedeutet so viel wie "Fachbereichsentwickler" und beschreibt technisch versierte Mitarbeiter, die softwarebasierte Anwendungen für ihren jeweiligen Fachbereich erstellen. Zu diesem Zweck wird ihnen von der Unternehmens-IT eine standardisierte Entwicklungsumgebung bereitgestellt - **Low-Code-Plattformen** fallen hier oftmals in die engere Wahl.

<https://www.cio.de/a/was-ist-ein-citizen-developer,3550357>

Gartner Glossary > Information Technology Glossary > C > Citizen Developer

Citizen Developer

A citizen developer is an employee who creates application capabilities for consumption by themselves or others, using tools that are not actively forbidden by IT or business units. A citizen developer is a persona, not a title or targeted role. They report to a business unit or function other than IT.

All citizen developers are business technologists. However, all business technologists are not necessarily citizen developers. There is no required designation of proficiency or time allocation for citizen developers but they must be legal employees of an organization.

<https://www.gartner.com/en/information-technology/glossary/citizen-developer>

Citizen developers are business users who can create their own applications with little to no coding knowledge. Citizen developers have no prior coding experience; that's why tools like low code and no-code development platforms enable them to build their apps.

<https://research.aimultiple.com/citizen-developer/>



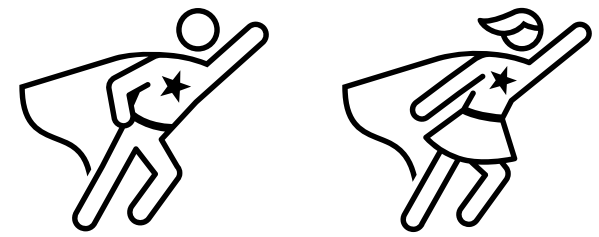

The Rise of the Citizen Developer

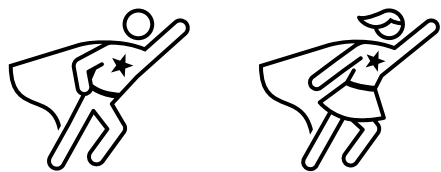

**The Rise
of the
Citizen Developer**

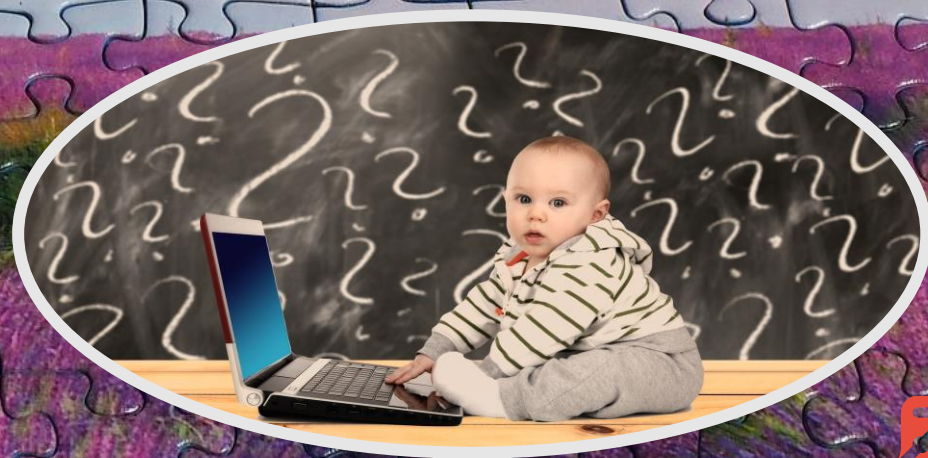





Ihr seid zu langsam

Ihr versteht uns nicht

Das ist zu teuer



Fachbereich

Ihr baut Schatten IT

Es ist nicht sicher

Es belastet uns noch mehr



IT



Citizen Developer ist kein Selbstläufer

Wenn die Komplexität steigt

Dieser Aufstieg der Low Code- und No-Code-Entwickler hat mittlerweile ein Level erreicht, auf dem es nötig wird, Citizen Development bewusst zu steuern und zu organisieren – vor allem wenn Mitarbeiter nicht nur Hilfssoftware für den Eigenbedarf erstellen, sondern diese Apps auch an Kollegen weitergeben, an Teams oder sogar an das ganze Unternehmen.

<https://www.dev-insider.de/wenn-fachmitarbeiter-citizen-development-betreiben-a-1059473/>

**Citizen developers
need leaders. Could that be you?**

<https://venturebeat.com/2022/04/05/citizen-developers-are-going-to-need-a-leader/>



IT und Fachbereich zusammenbringen

**Schatten IT
durch
Zusammenarbeit
vermeiden**

Geführt durch IT



IT und Fachbereich zusammenbringen

**Schatten IT
durch
Zusammenarbeit
vermeiden**

Geführt durch IT

**Passendes Low
Code-Software
finden oder zur
Verfügung
stellen**

Unterstützt mit Tools



IT und Fachbereich zusammenbringen

Schatten IT
durch
Zusammenarbeit
vermeiden

Geführt durch IT

Passendes Low
Code-Software
finden oder zur
Verfügung
stellen

Unterstützt mit Tools

Entsprechendes
Training
Programm ins
leben rufen

Entsprechend geschult



IT und Fachbereich zusammenbringen

Schatten IT
durch
Zusammenarbeit
vermeiden

Geführt durch IT

Passendes Low
Code-Software
finden oder zur
Verfügung
stellen

Unterstützt mit Tools

Entsprechendes
Training
Programm ins
leben rufen

Entsprechend geschult

Idealerweise ein
crossfunktionales
Team aufstellen

Gemeinsam im Team





„The Rise of the Citizen Developer“

... in process automation

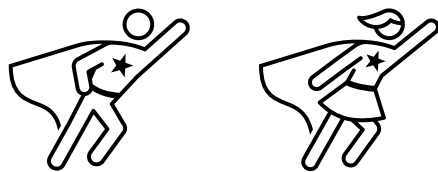
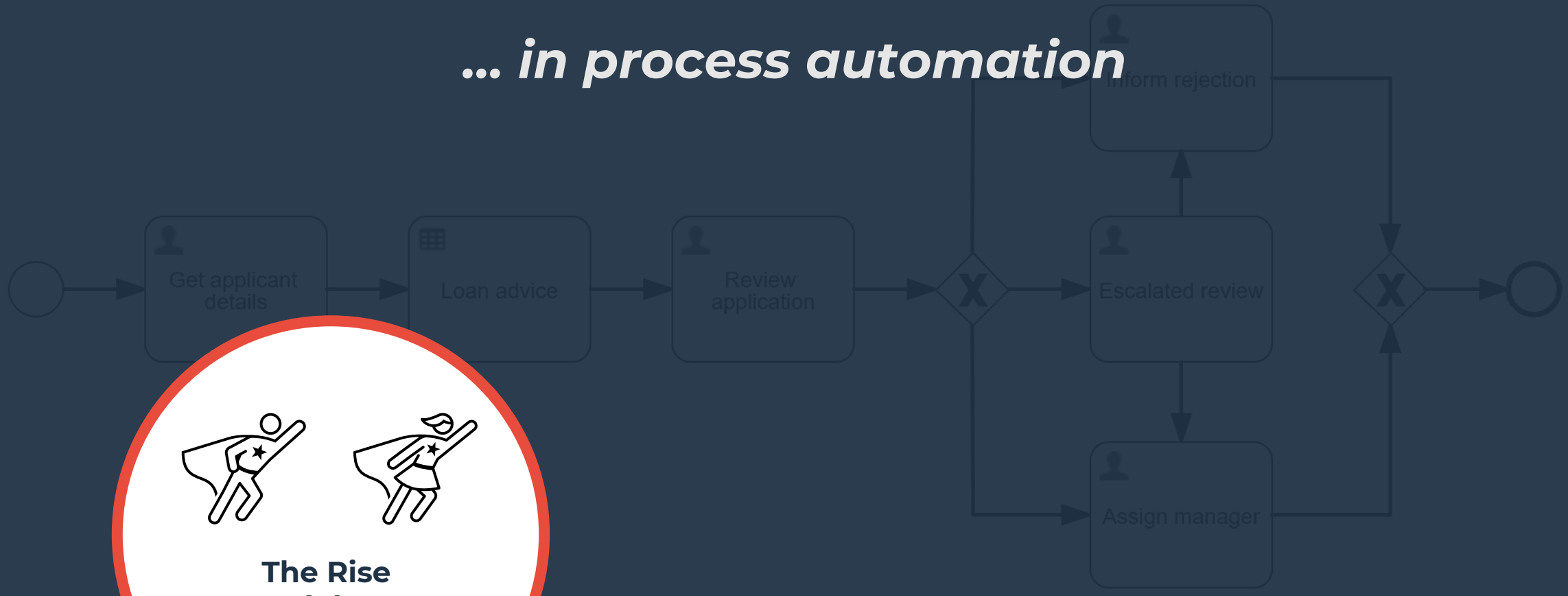

**The Rise
of the
Citizen Developer**

BPMN – die Grundidee

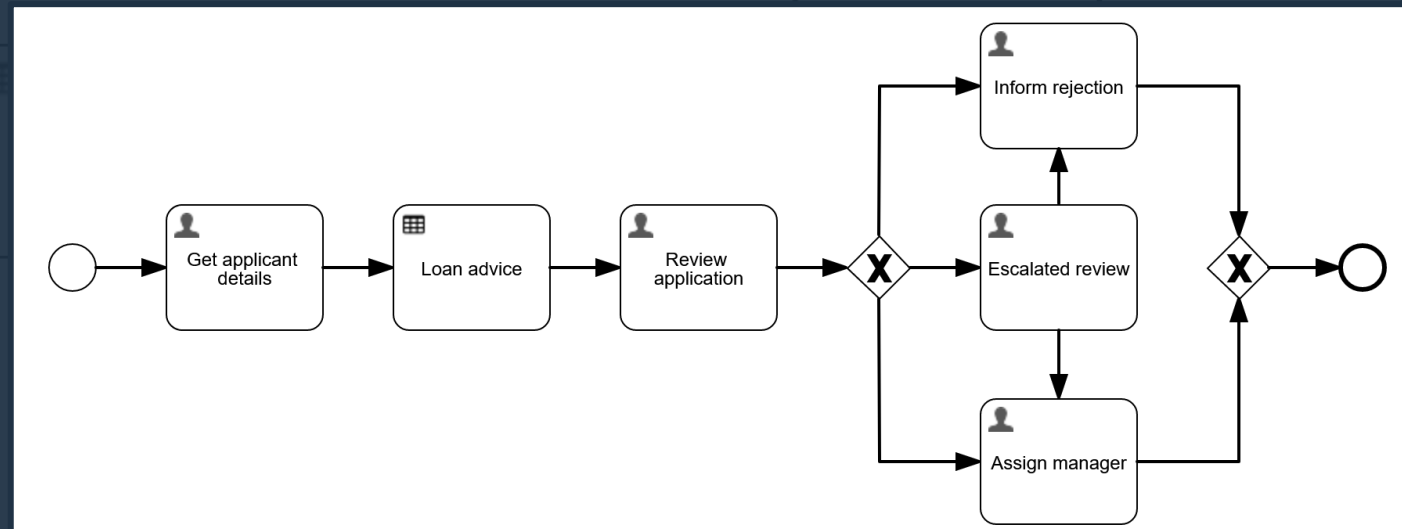

BPMN – die Grundidee

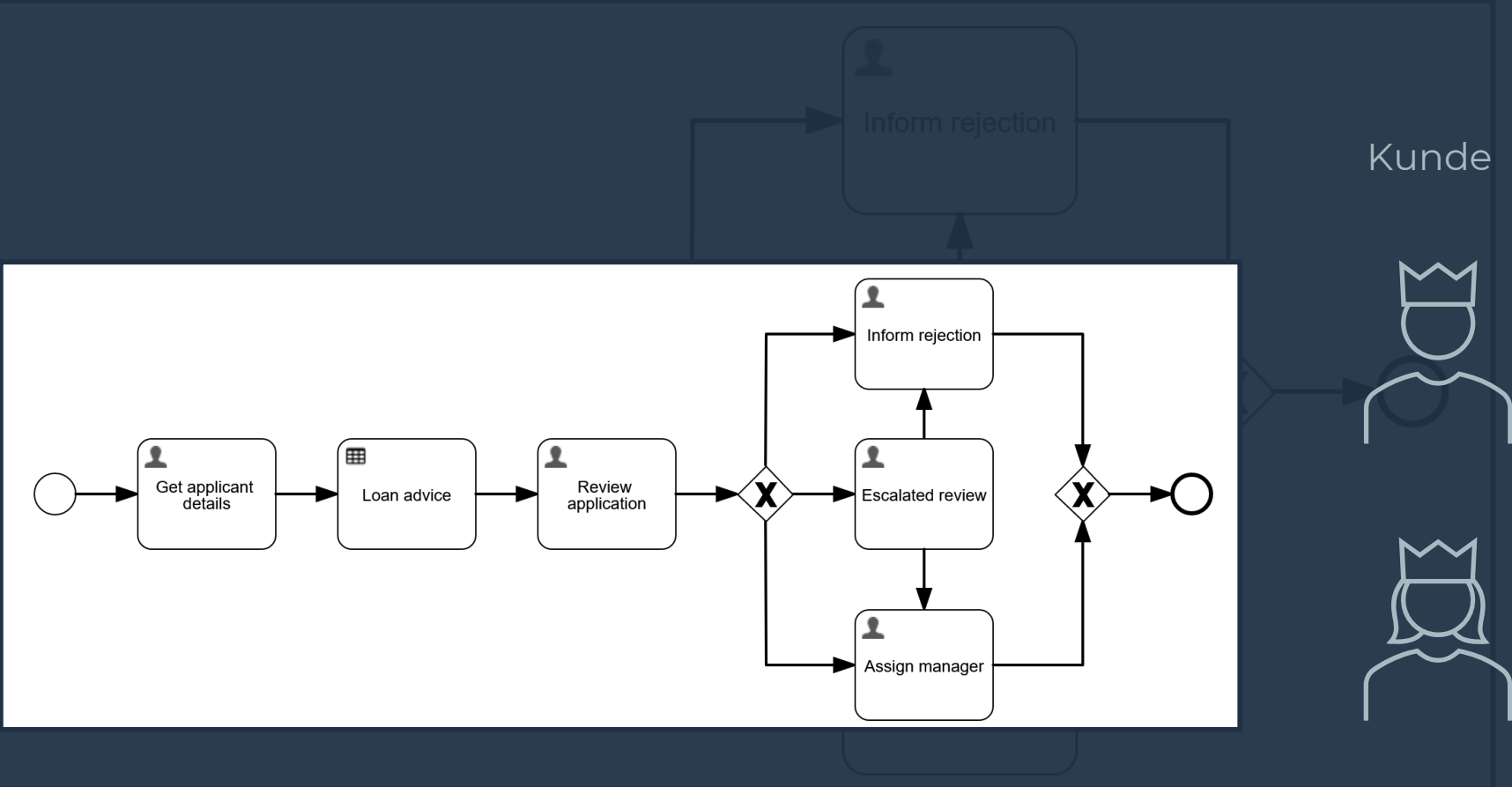

Kunde



BPMN war schon immer Low-Code

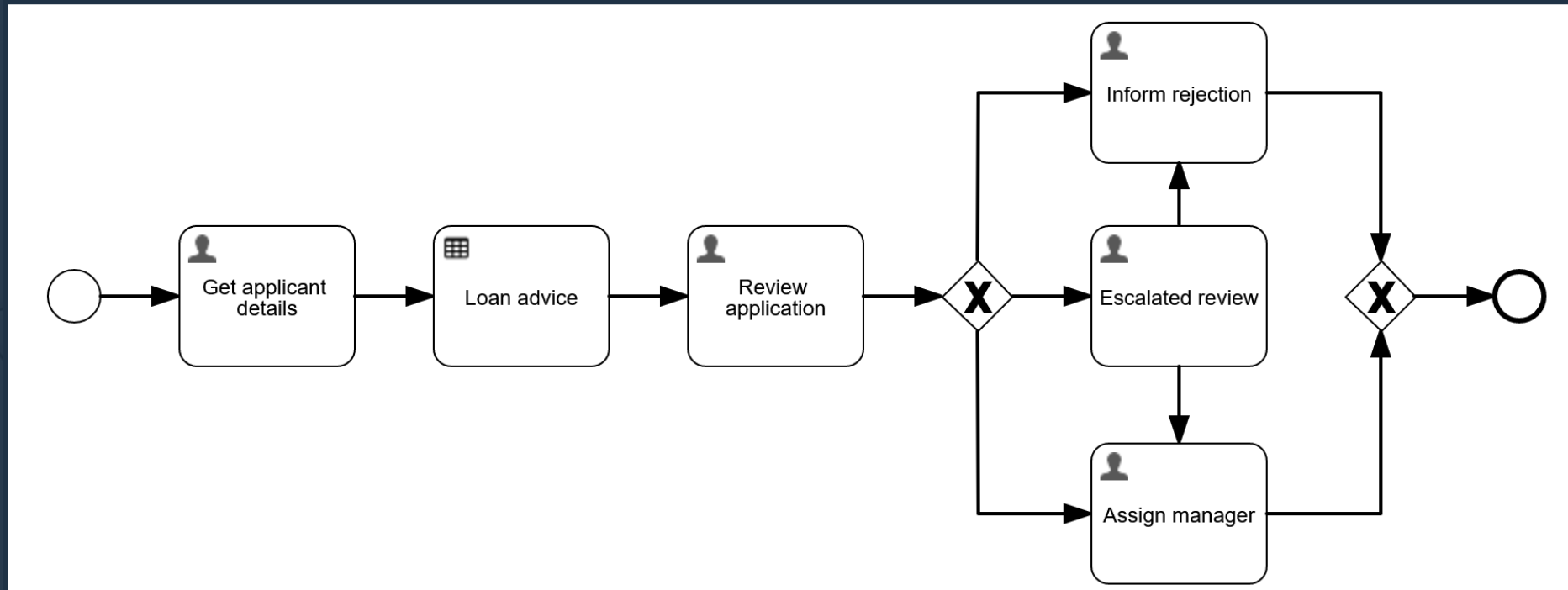

BPMN war schon immer Low-Code

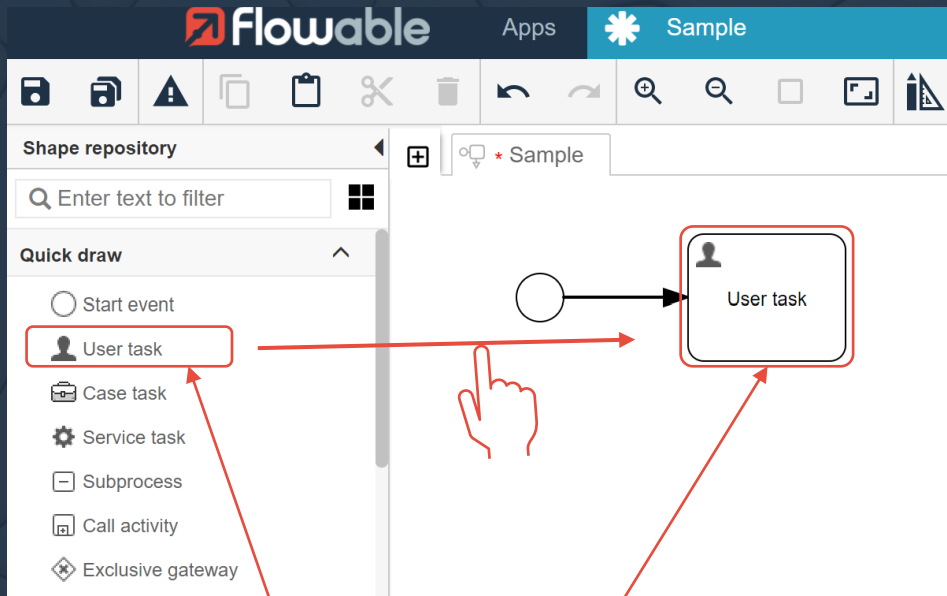

drag

drop



```
<definitions xmlns="http://www.omg.org/spec/BPMN/20100524/MODEL" xmlns:xsi="http://www.w3.org/2001/XMLSchema-instance" xsi:schemaLocation="http://www.omg.org/spec/BPMN/20100524/MODEL bpmn20.xml">
  <process id="sample" name="Sample" isExecutable="true" flowable:candidateStarterGroups="{}">
    <startEvent id="startnoneevent1" flowable:initiator="initiator" flowable:formFieldValue="{}">
      <sequenceFlow id="sequenceFlow1" sourceRef="startnoneevent1" targetRef="formTask1"/>
    </startEvent>
    <userTask id="formTask1" name="User task" flowable:assignee="{${initiator}}" flowable:candidateAssignees="{}">
    </userTask>
  </process>
</definitions>
<bpmndi:BPMNDiagram id="BPMNDiagram_sample">
  <bpmndi:BPMNPlane bpmnElement="sample" id="BPMNPlane_sample">
    <bpmndi:BPMNShape bpmnElement="startnoneevent1" id="BPMNShape_startnoneevent1">
      <omgdc:Bounds height="30.0" width="30.0" x="117.0" y="261.0"/>
    </bpmndi:BPMNShape>
    <bpmndi:BPMNShape bpmnElement="formTask1" id="BPMNShape_formTask1">
      <omgdc:Bounds height="80.0" width="100.0" x="226.0" y="236.0"/>
    </bpmndi:BPMNShape>
    <bpmndi:BPMNEdge bpmnElement="sequenceFlow1" id="BPMNEdge_sequenceFlow1" flowable:candidateStarters="{}">
      <omgdi:waypoint x="146.9499991186577" y="276.0"/>
      <omgdi:waypoint x="225.9999999999646" y="276.0"/>
    </bpmndi:BPMNEdge>
  </bpmndi:BPMNPlane>
</bpmndi:BPMNDiagram>
</definitions>
```

code



Teamzusammenstellung früher



CPO
PL



Scrum Master



Product Owner
Process owner
Platform owner



Kunde



Testmanager



Tester



Fachexperte



Fachexperte



Entwickler



Entwickler



Entwickler



Entwickler



Entwickler

Projektteam



Architekt



Architekt



Architekt



Architekt

Architekturteam



Prozessautomatisierung



Prozessautomatisierung

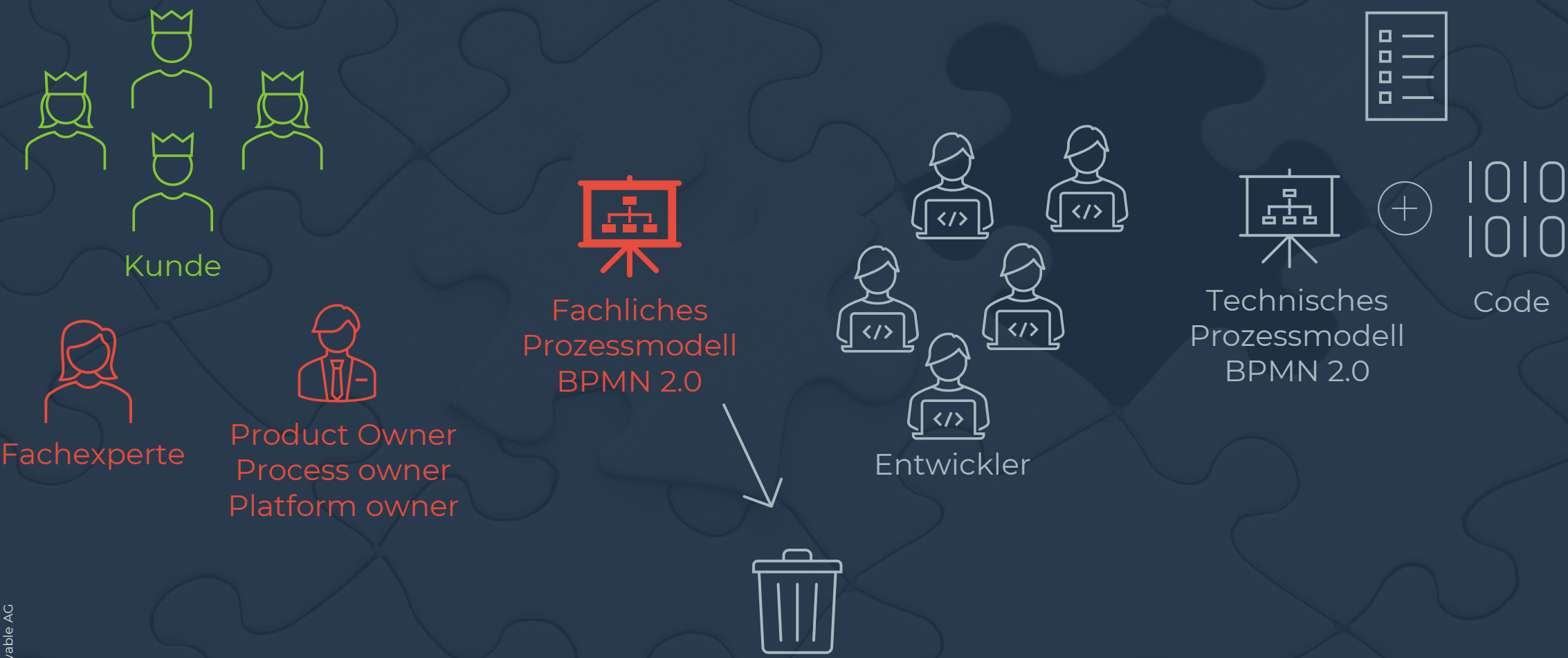

Prozessautomatisierung

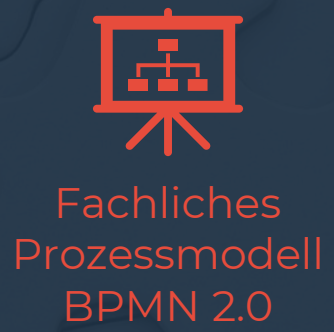

Unit Tests

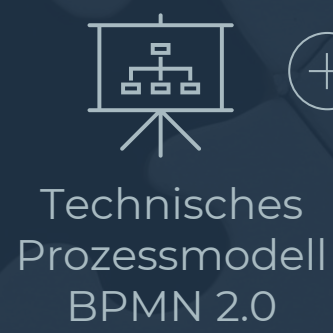

1010
1010
Code



Prozessautomatisierung

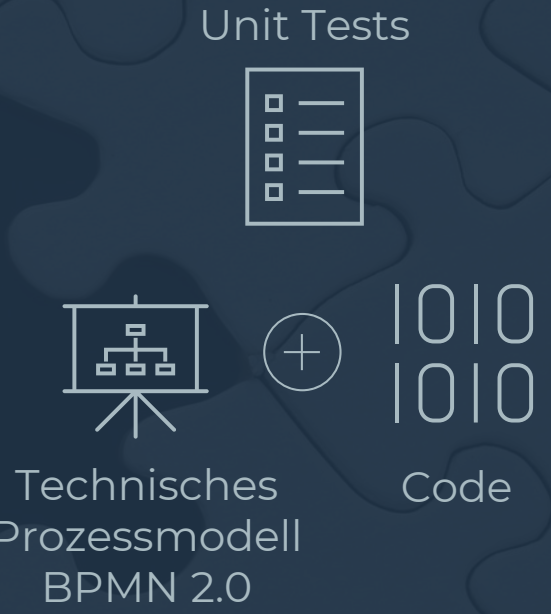
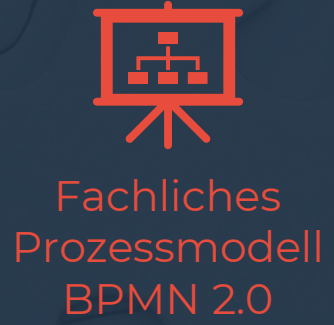

Dabei nur einfache Prozesse

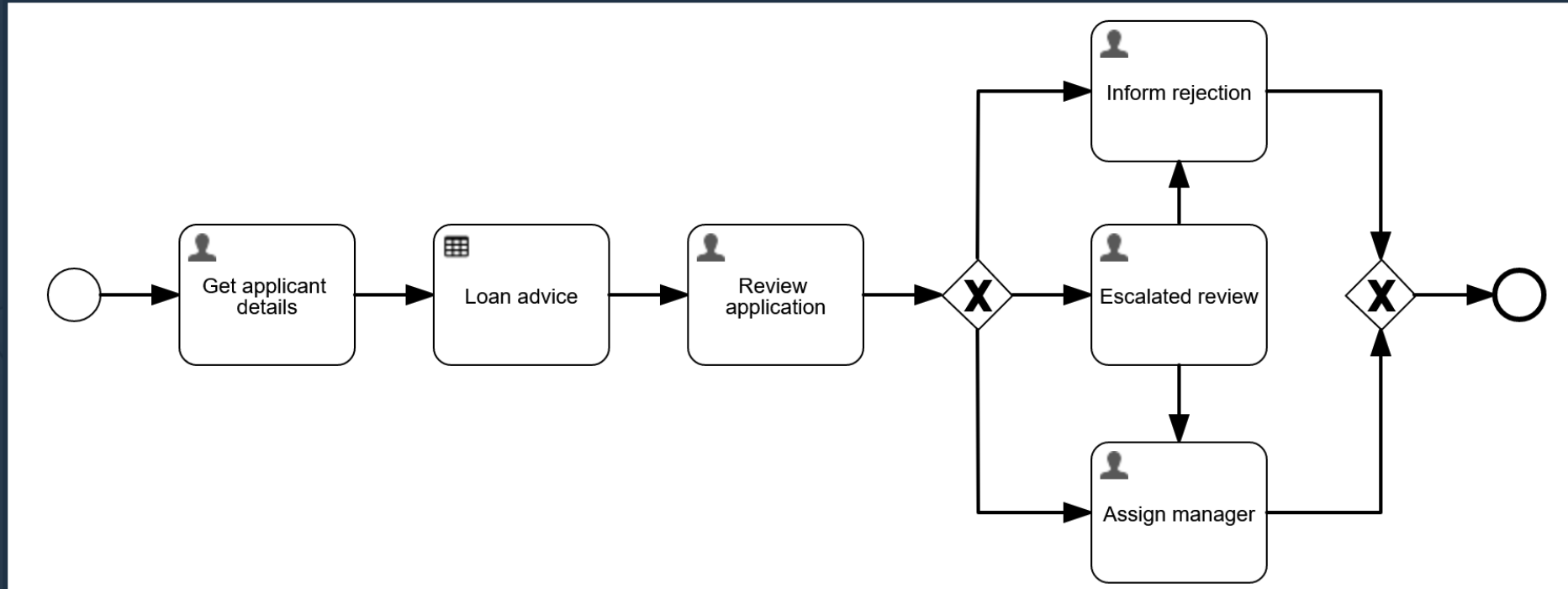



Später dann ...

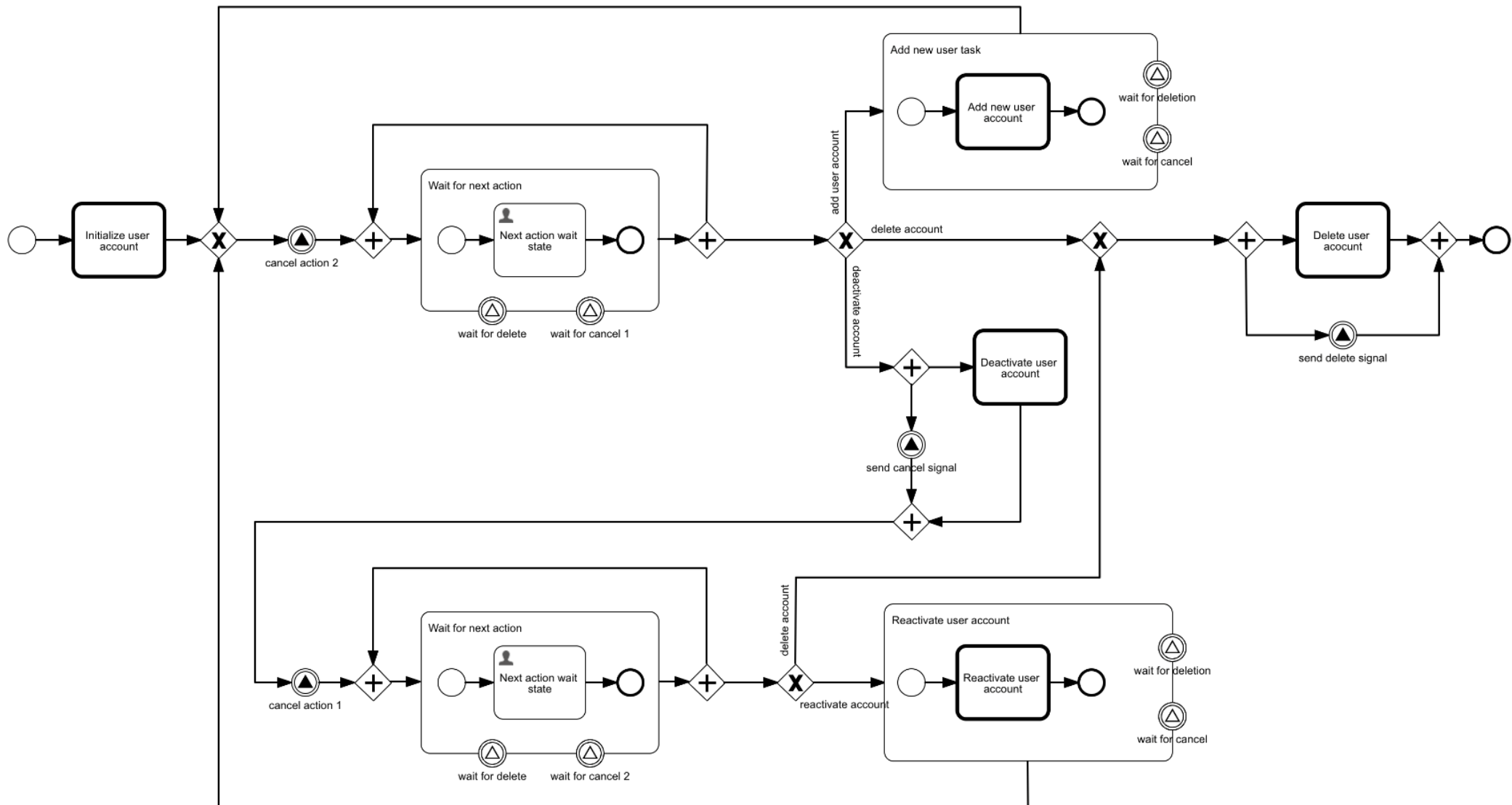

Prozessautomatisierung

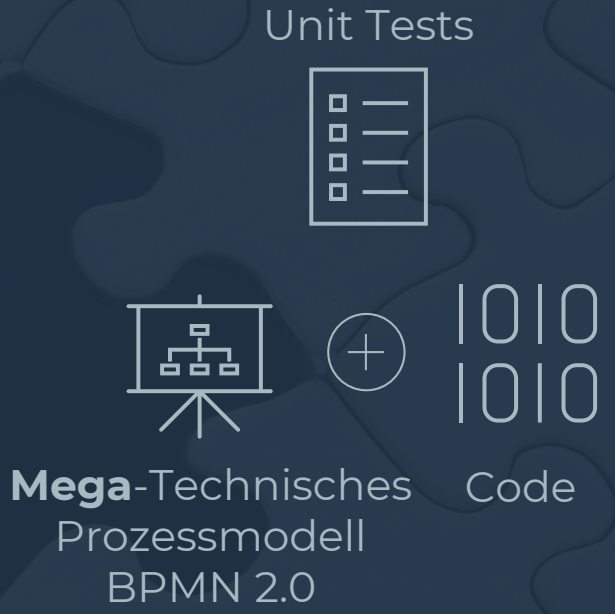
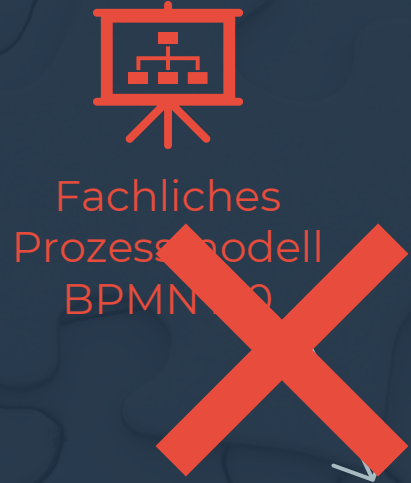

Prozessautomatisierung



Kunde

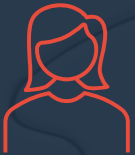

Fachexperte



Product Owner
Process owner
Platform owner



Stories



Entwickler

Unit Tests



Mega-Technisches
Prozessmodell
BPMN 2.0



1010
1010

Code



Fachliches
Prozessmodell
bpmn 2.0



Prozessautomatisierung



Kunde

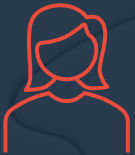

Fachexperte



Product Owner
Process owner
Platform owner



Stories



Entwickler

Unit Tests



Mega-Technisches
Prozessmodell
BPMN 2.0



1010
1010

Code



Fachliches
Prozessmodell
bpmn 2.0







BPMN

DMN



BPMN

CMMN

DMN

Die BPM-Trilogie

CMMN

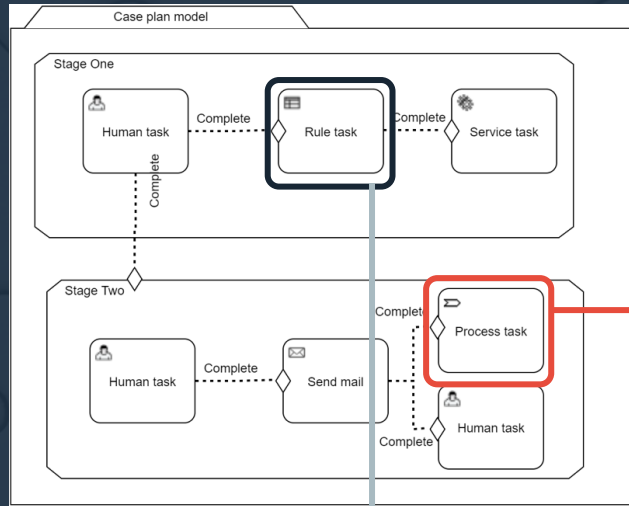

BPMN

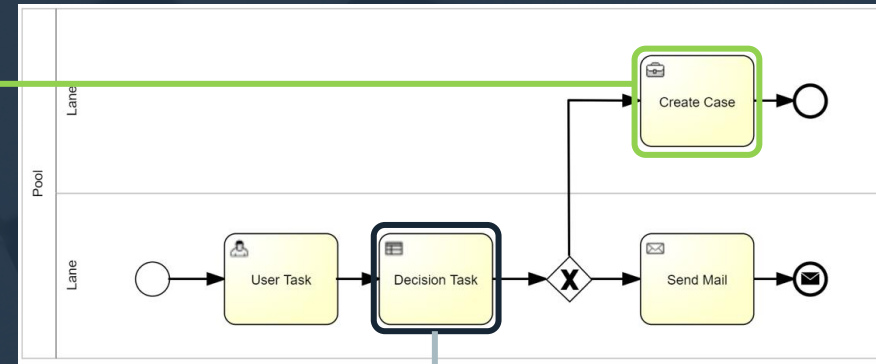

DMN

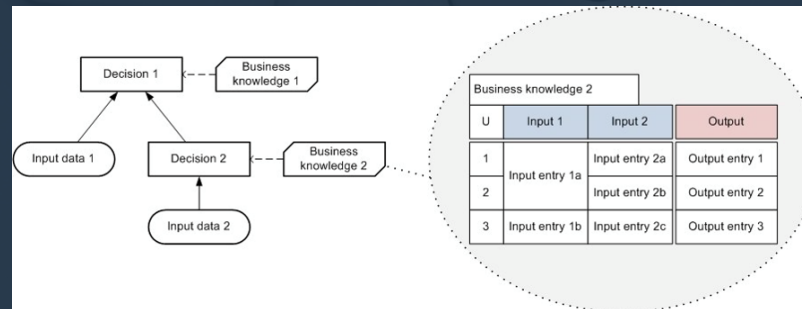

Beispiel BPMN

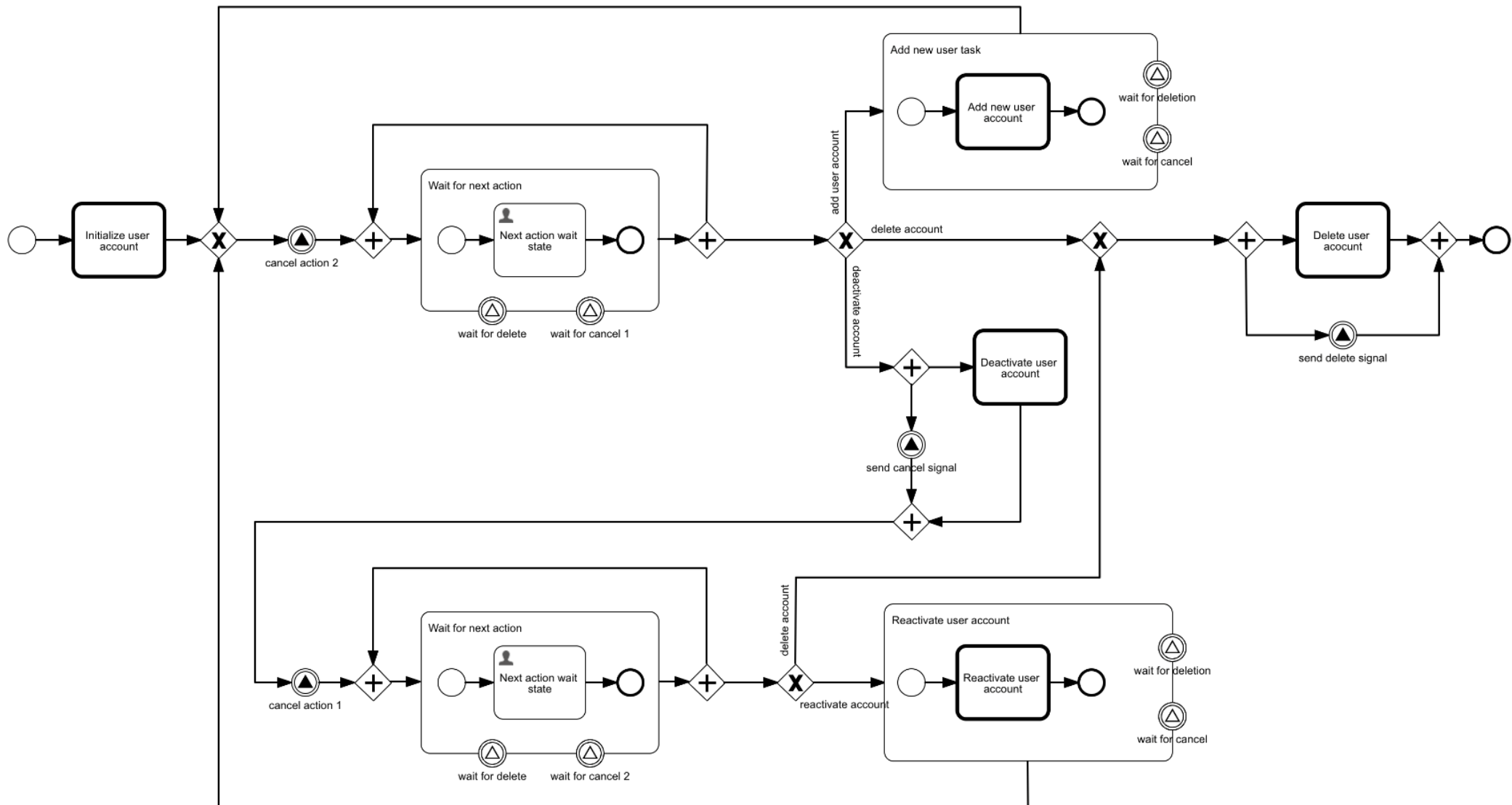

Beispiel CMMN

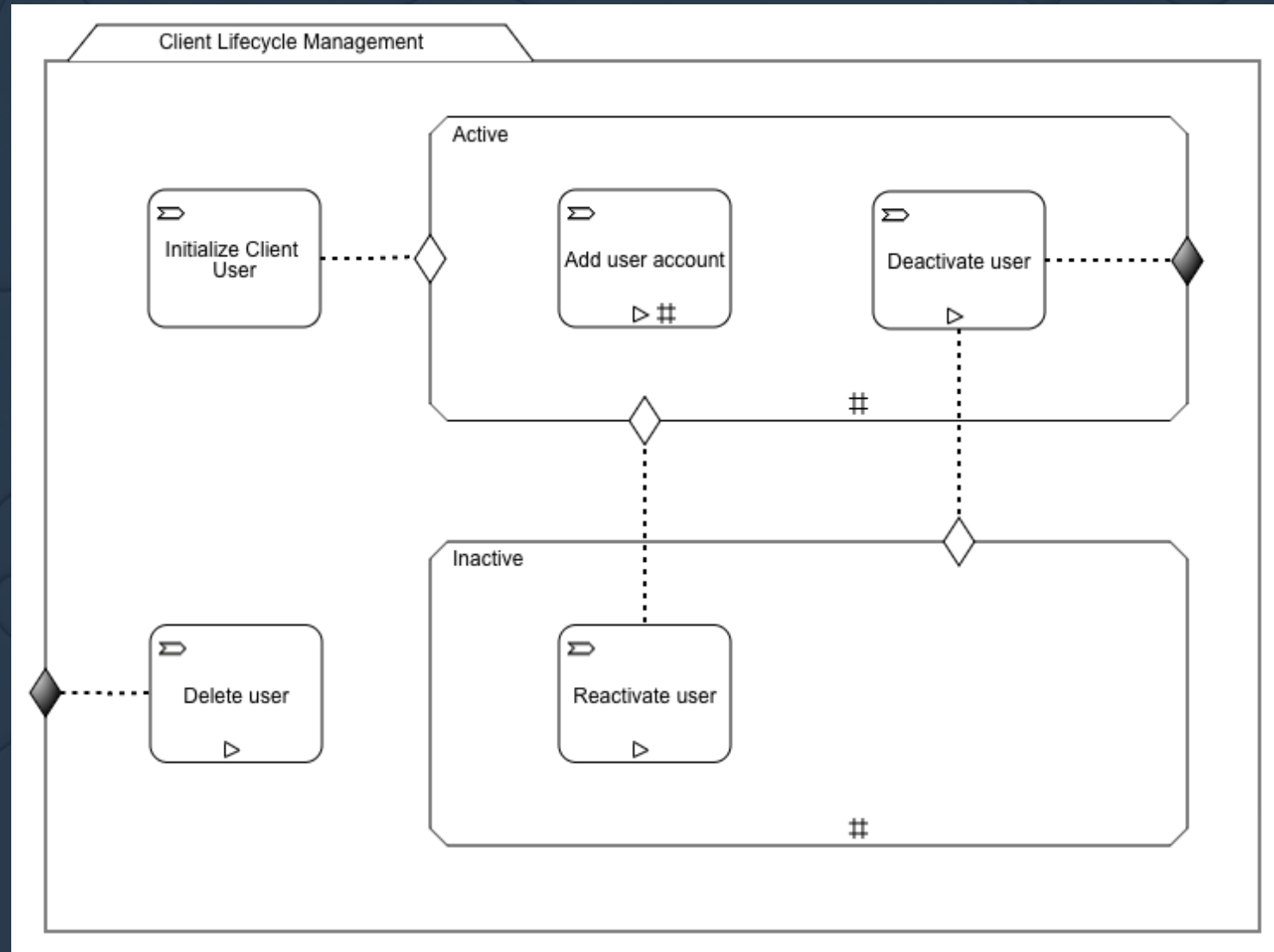

Teamzusammenstellung jetzt



CPO
PL



Product Owner
Process owner



Kunde



Product Owner
Process owner



Kunde



Platform owner



Scrum Master



Scrum Master



Scrum Master



Tester



Modeller



Modeller



Entwickler



Tester



Modeller



Entwickler



Prozess



Architekt

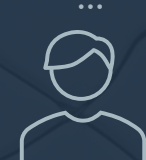

UX



Entwickler

Domäne A

Domäne B

Architekturteam



Flowable Entwicklung

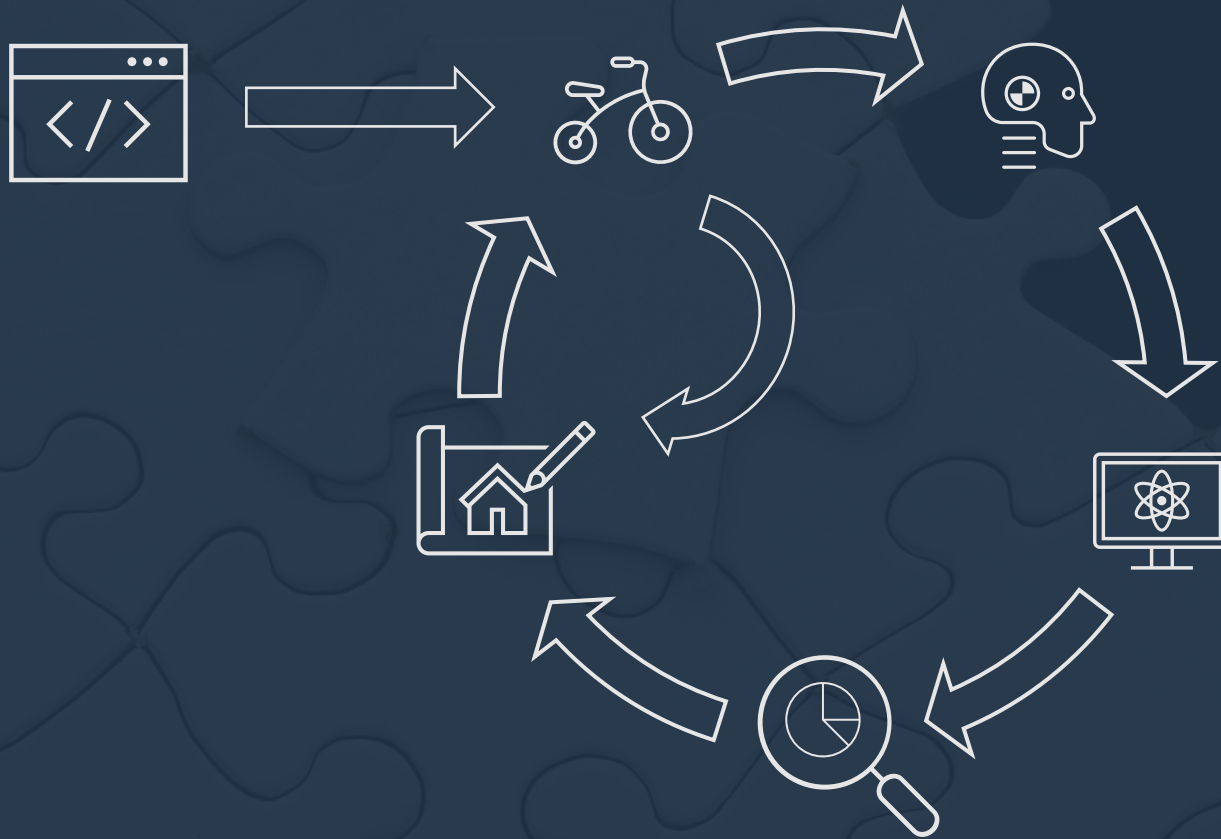

Flowable Entwicklung



Flowable Entwicklung

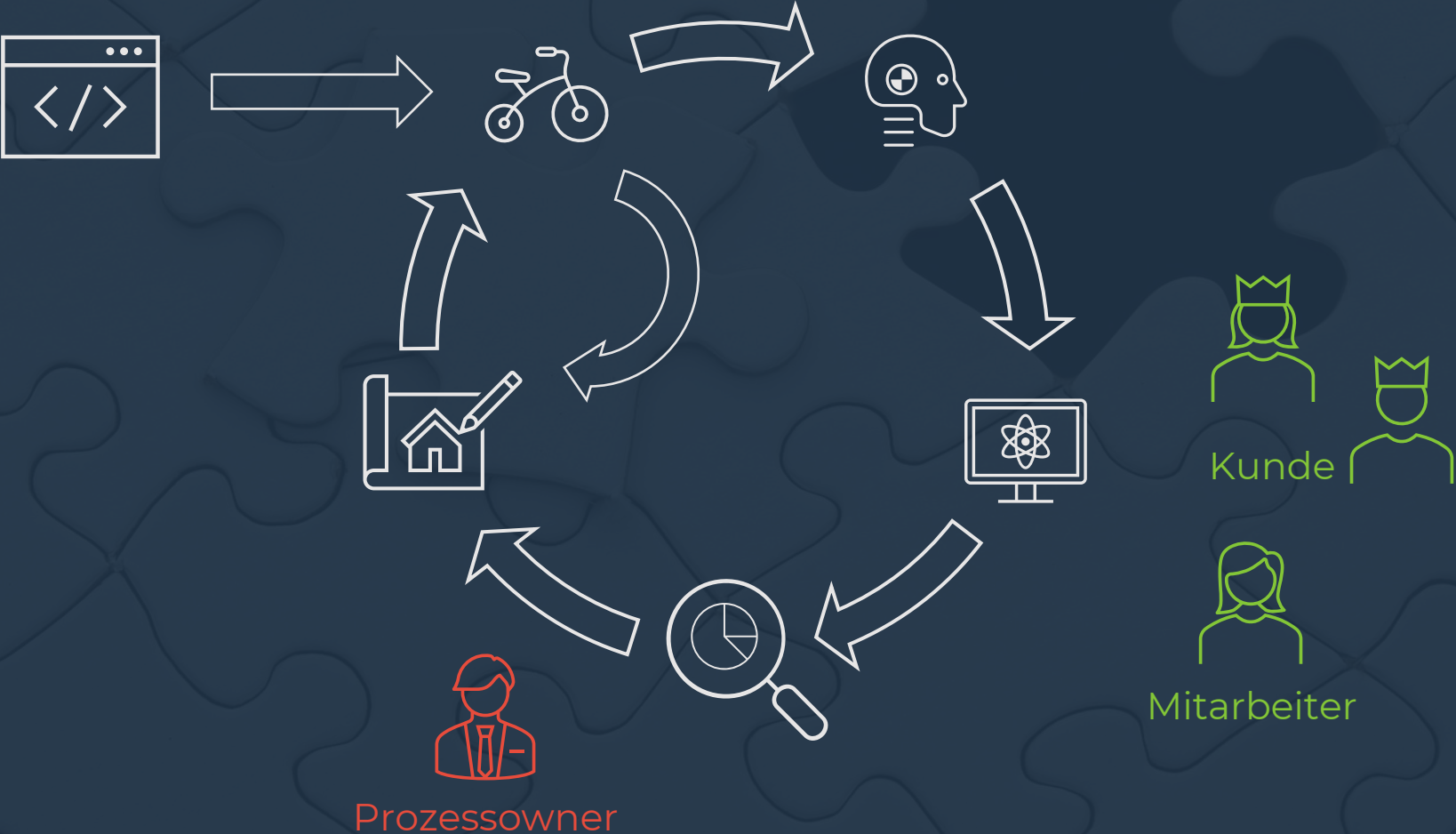

Flowable Entwicklung

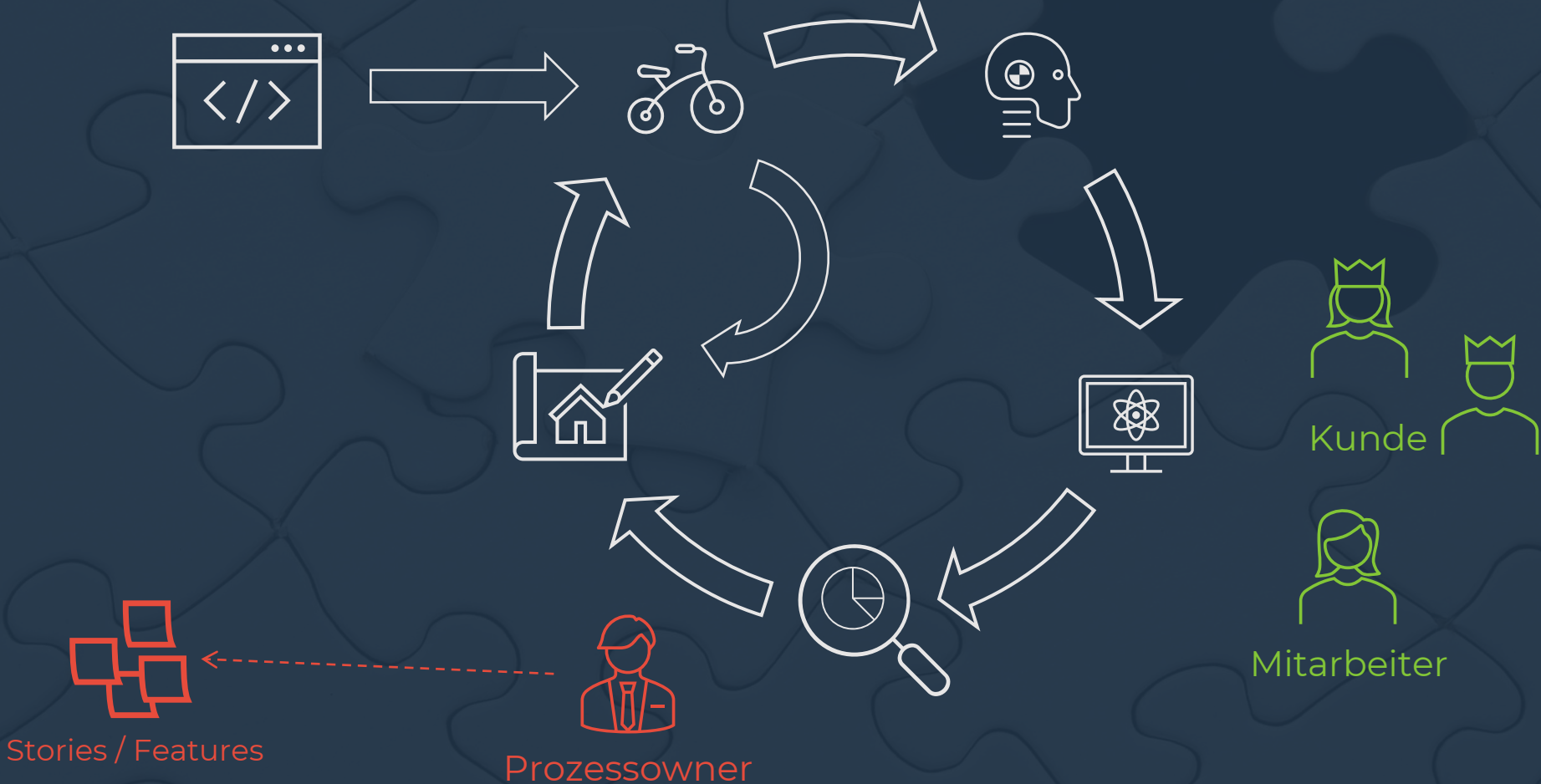

Flowable Entwicklung

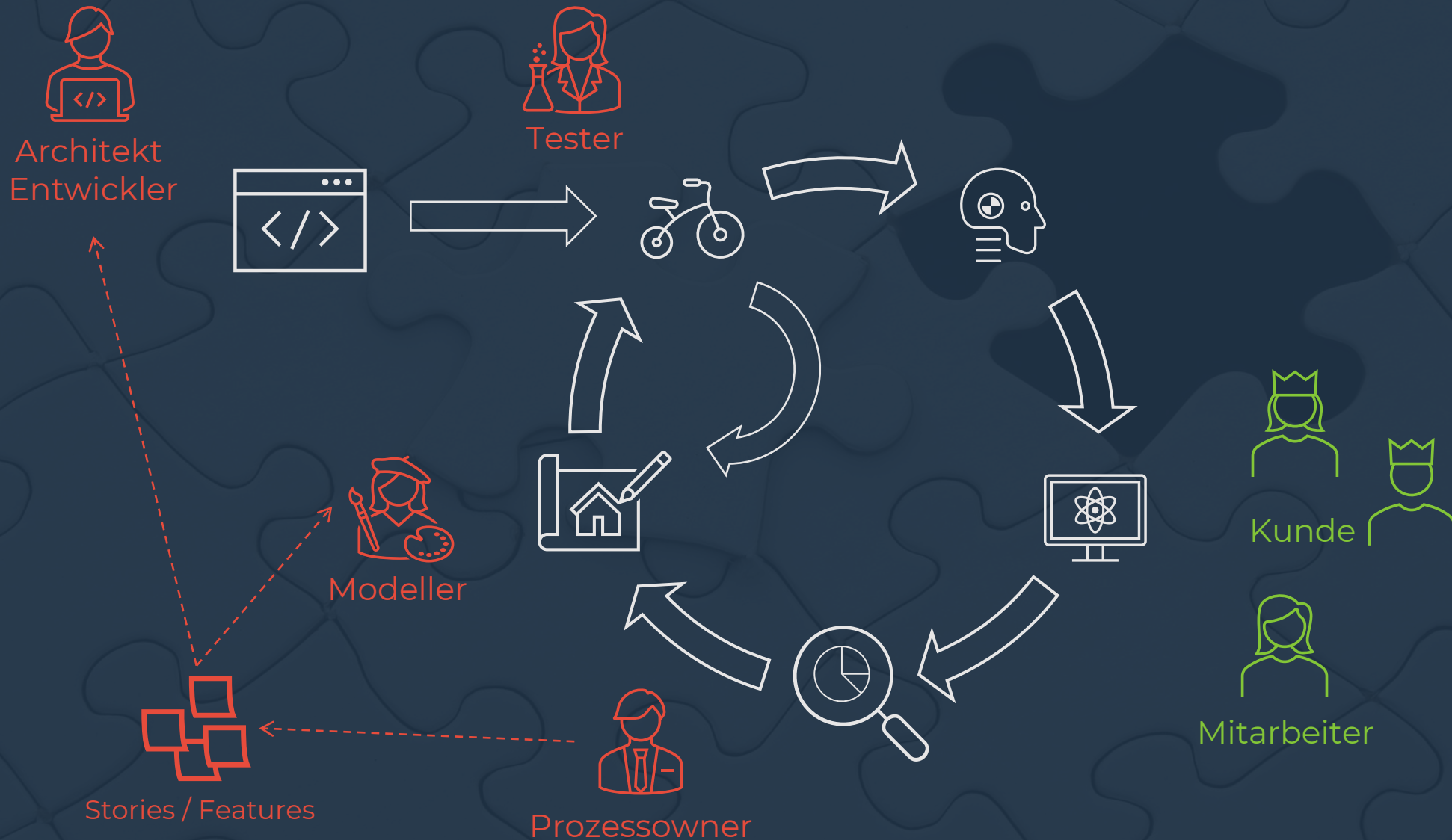

Flowable Entwicklung

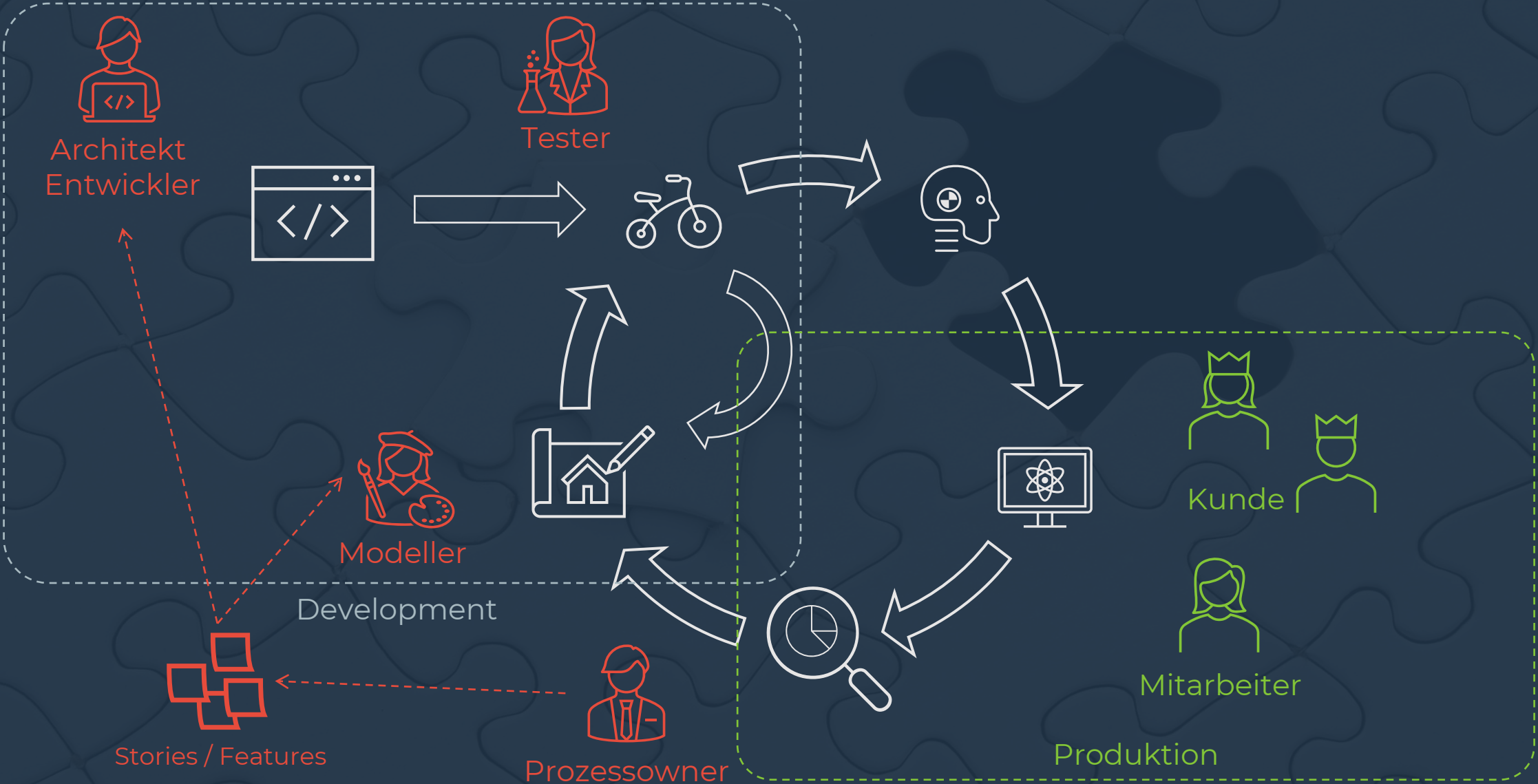

Flowable Entwicklung

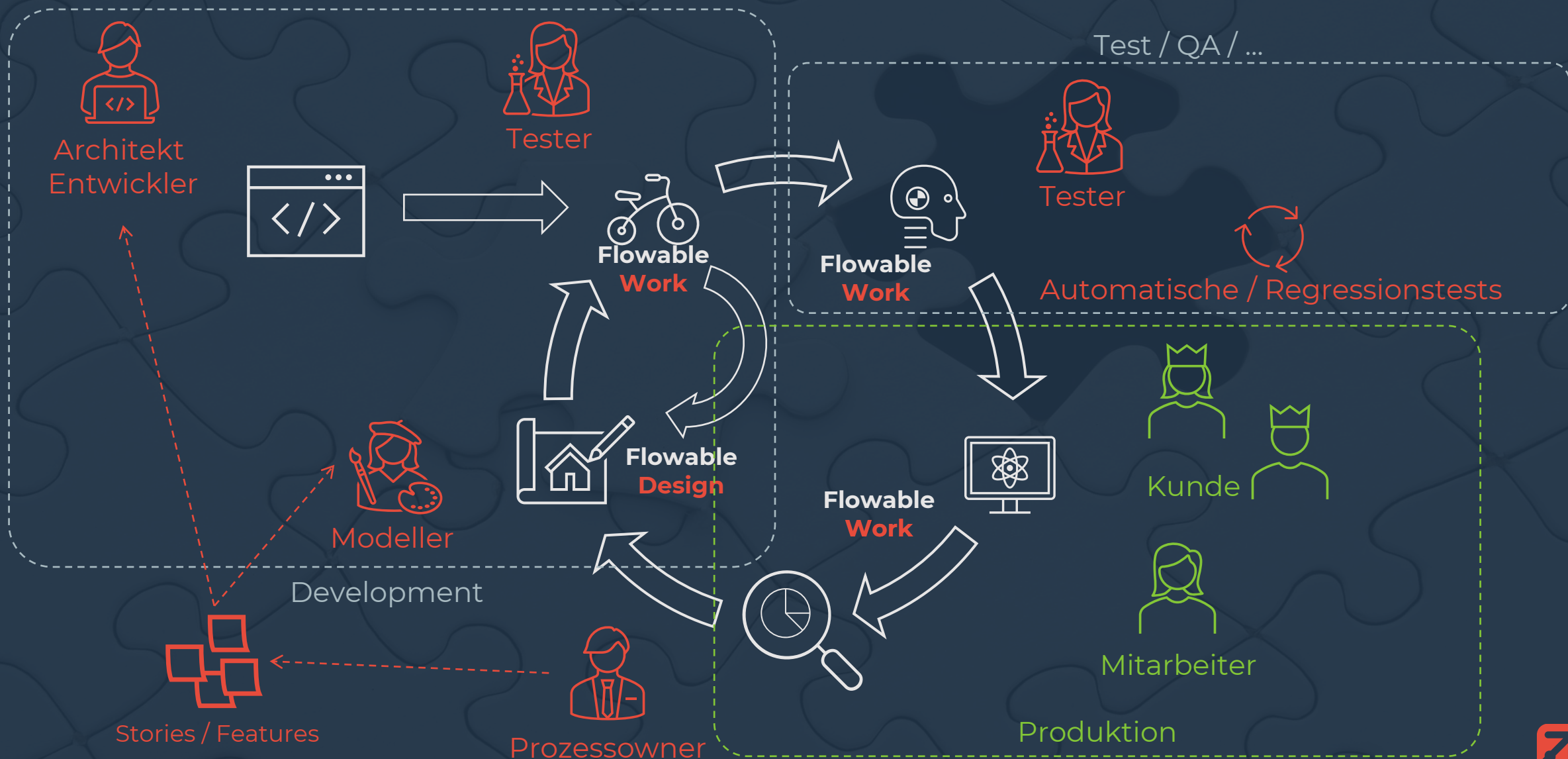

Flowable Entwicklung

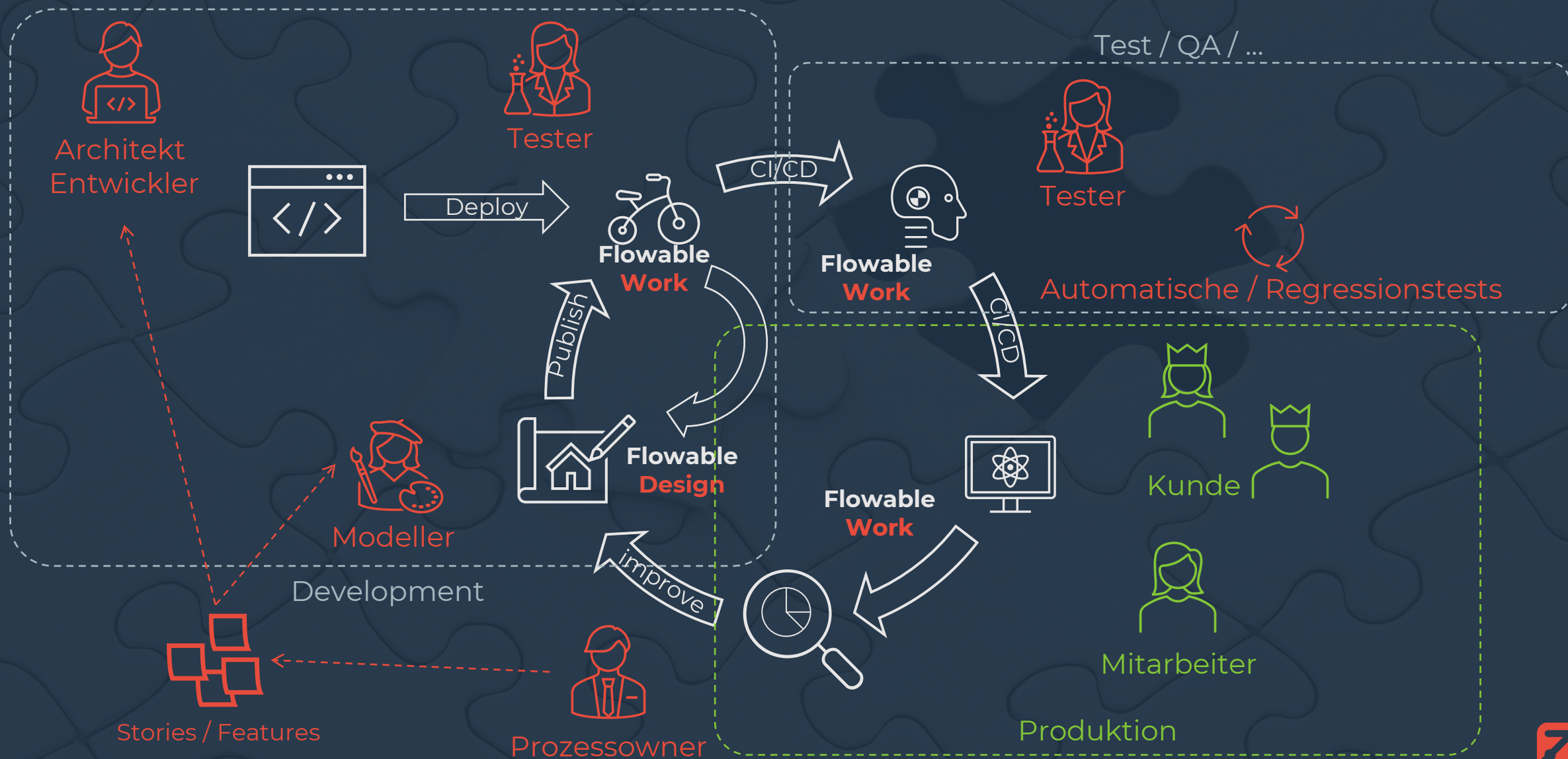

Flowable Testing



Flowable
Work



Flowable
Work

Automatische / Regressionstests



Flowable
Work



Flowable
Design



Flowable Testing

Architekt
Entwickler



Tester

Flowable
Work





Flowable
Work

Automatische / Regressionstests



Modeller

Flowable
Design



Flowable
Work

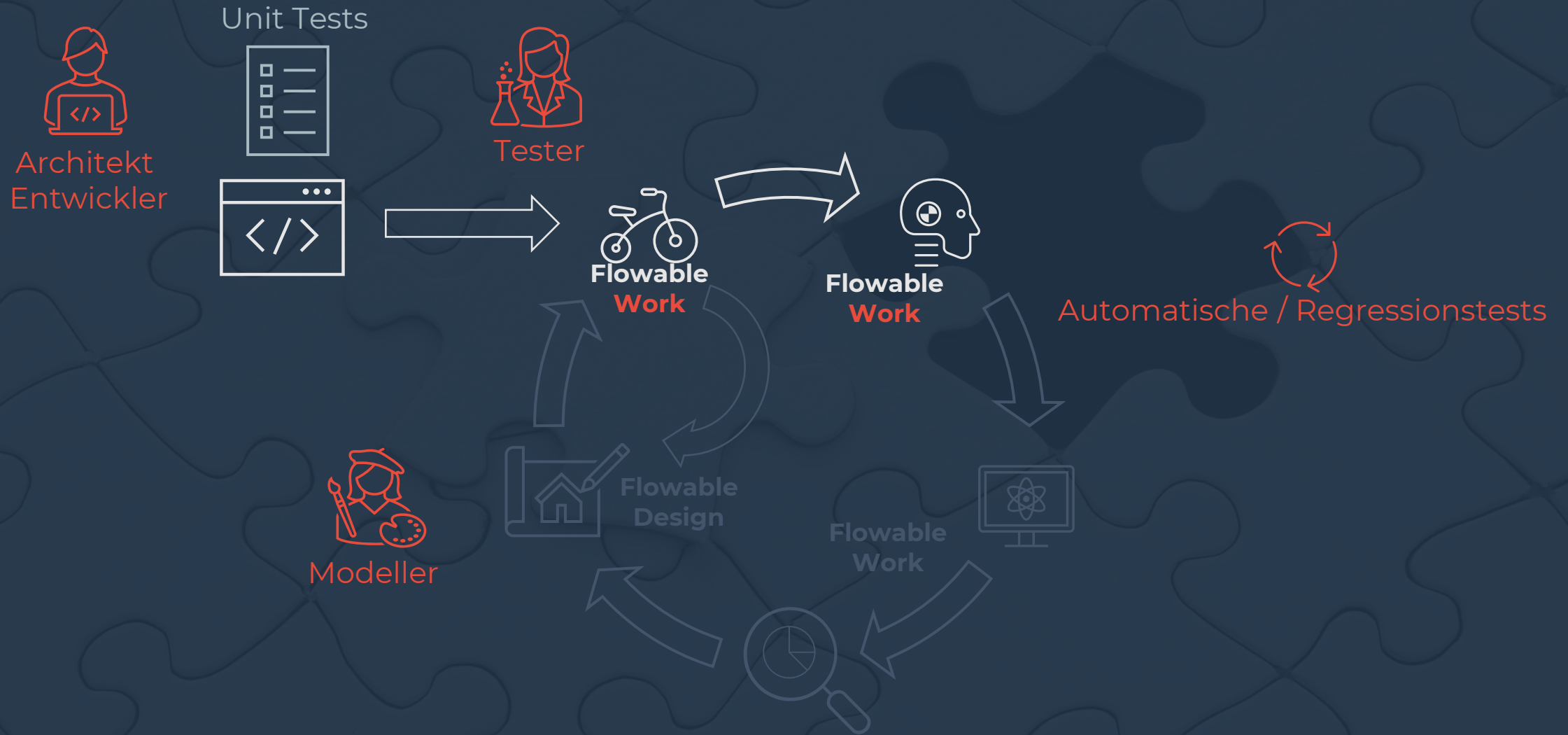

Flowable Testing

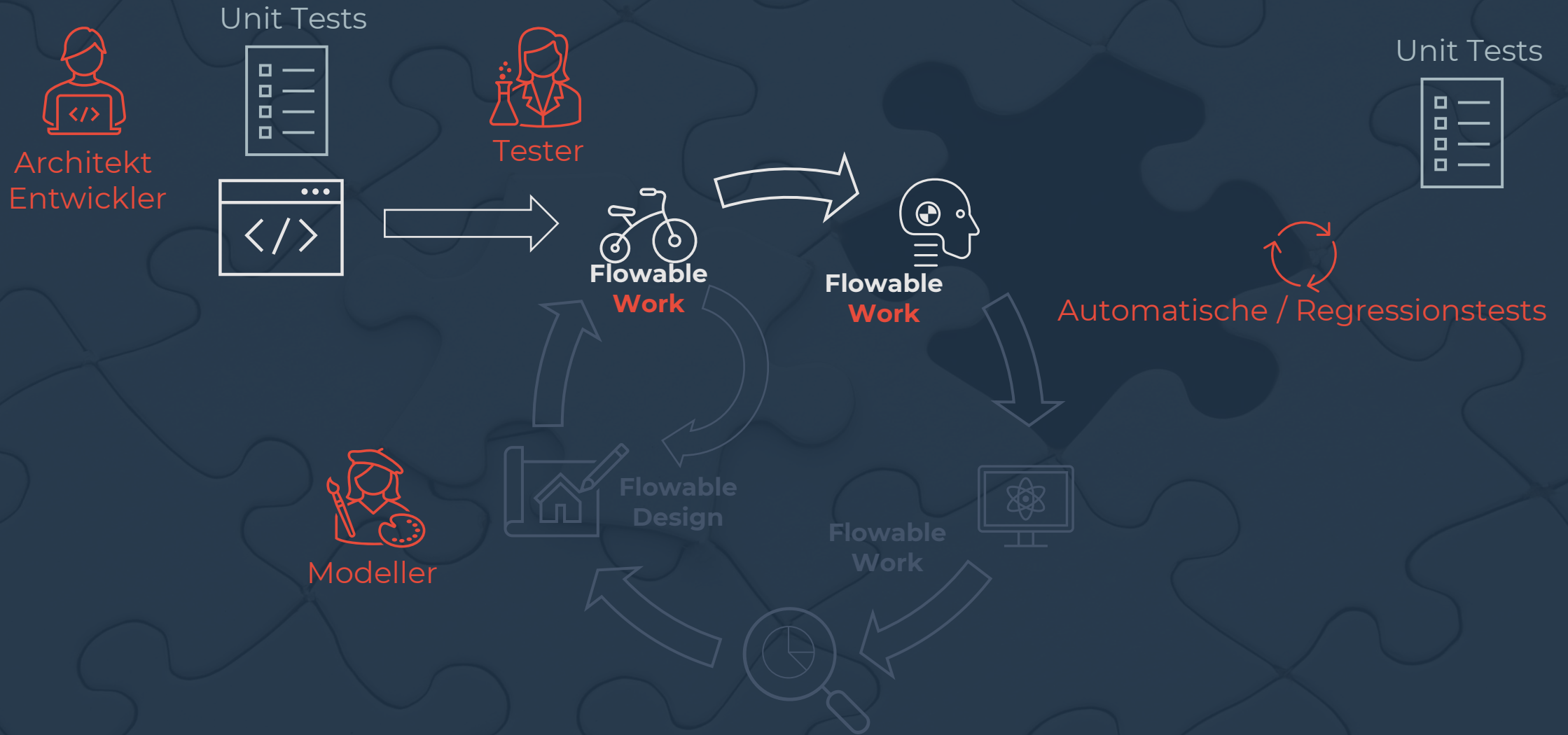

Flowable Testing



Flowable Testing

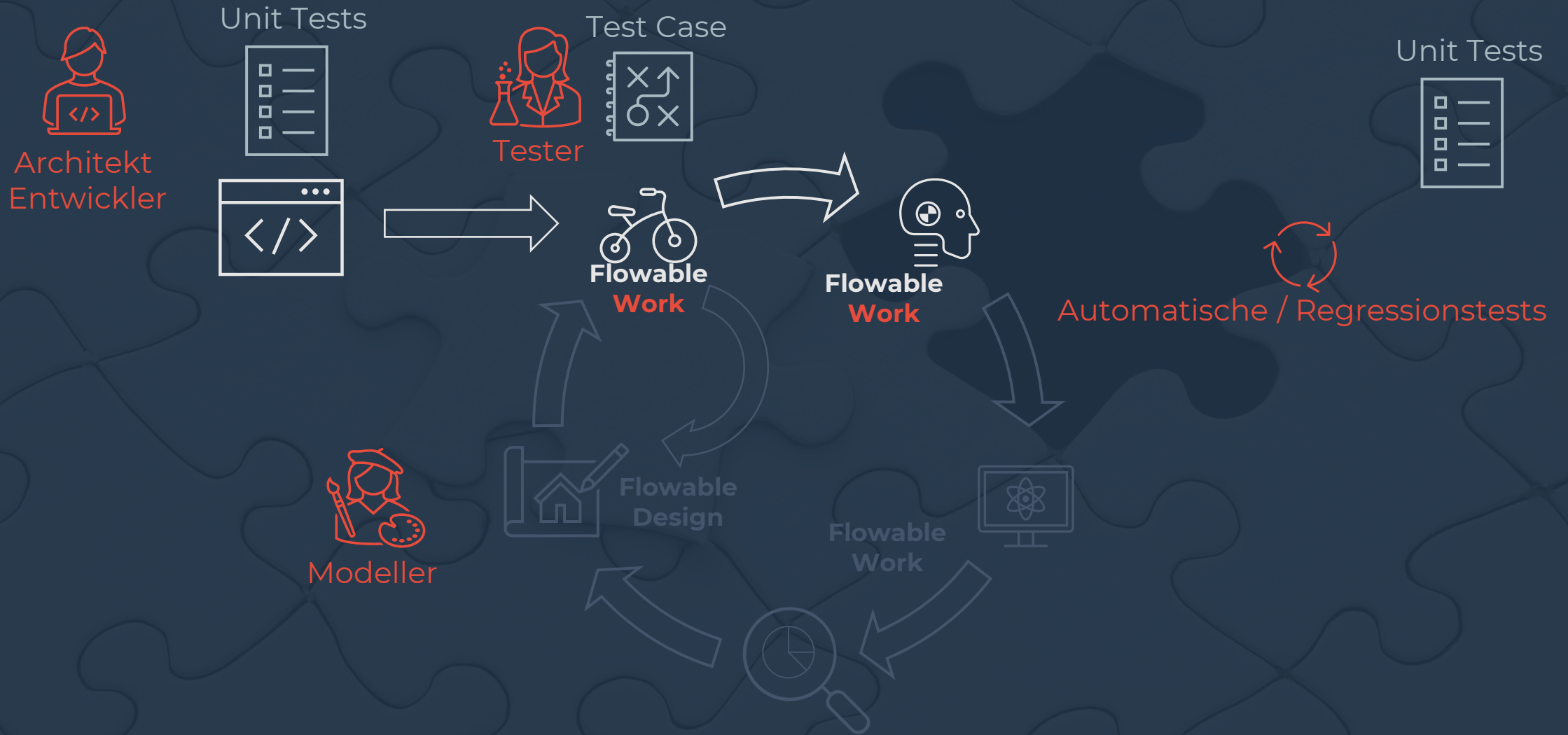

Flowable Testing

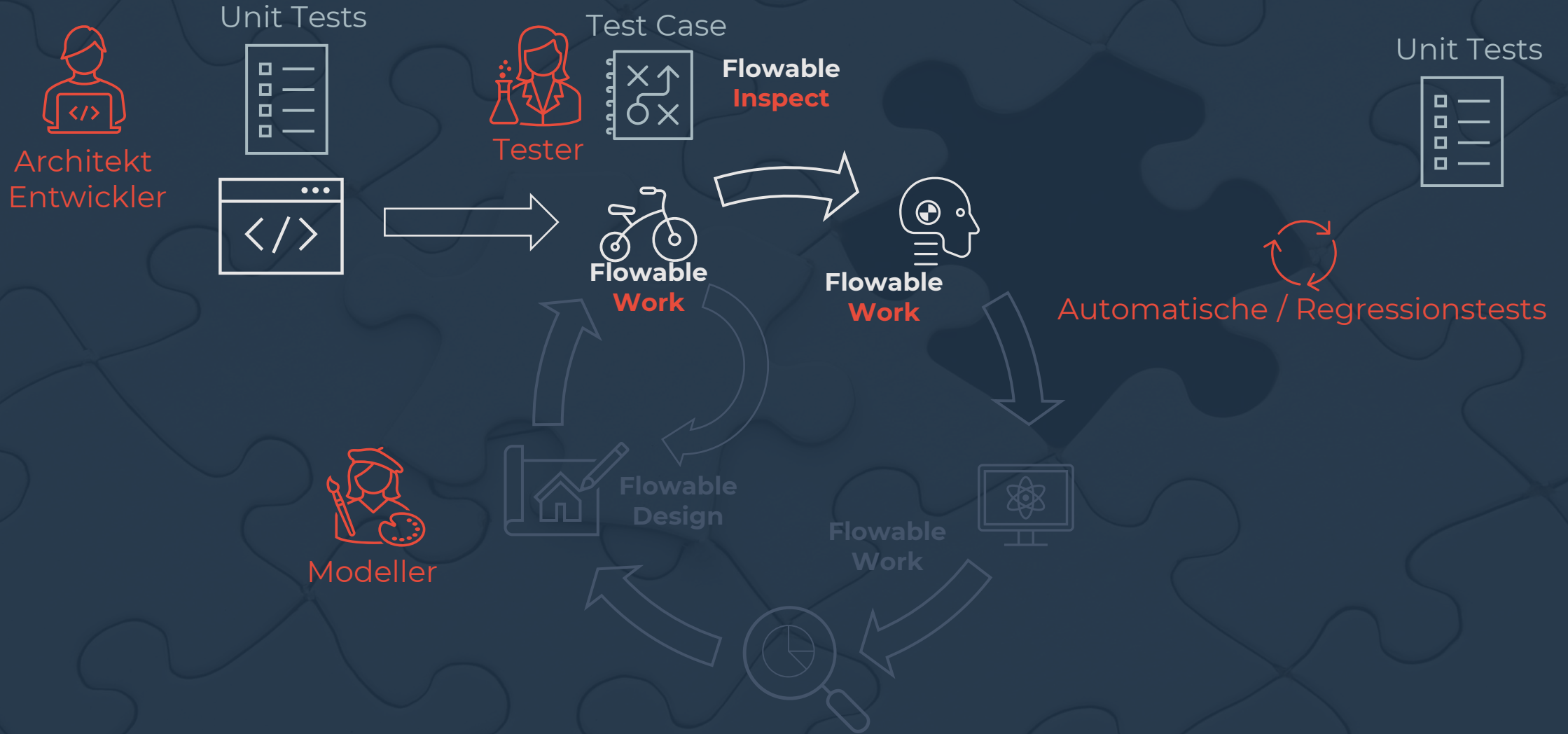

Flowable Testing

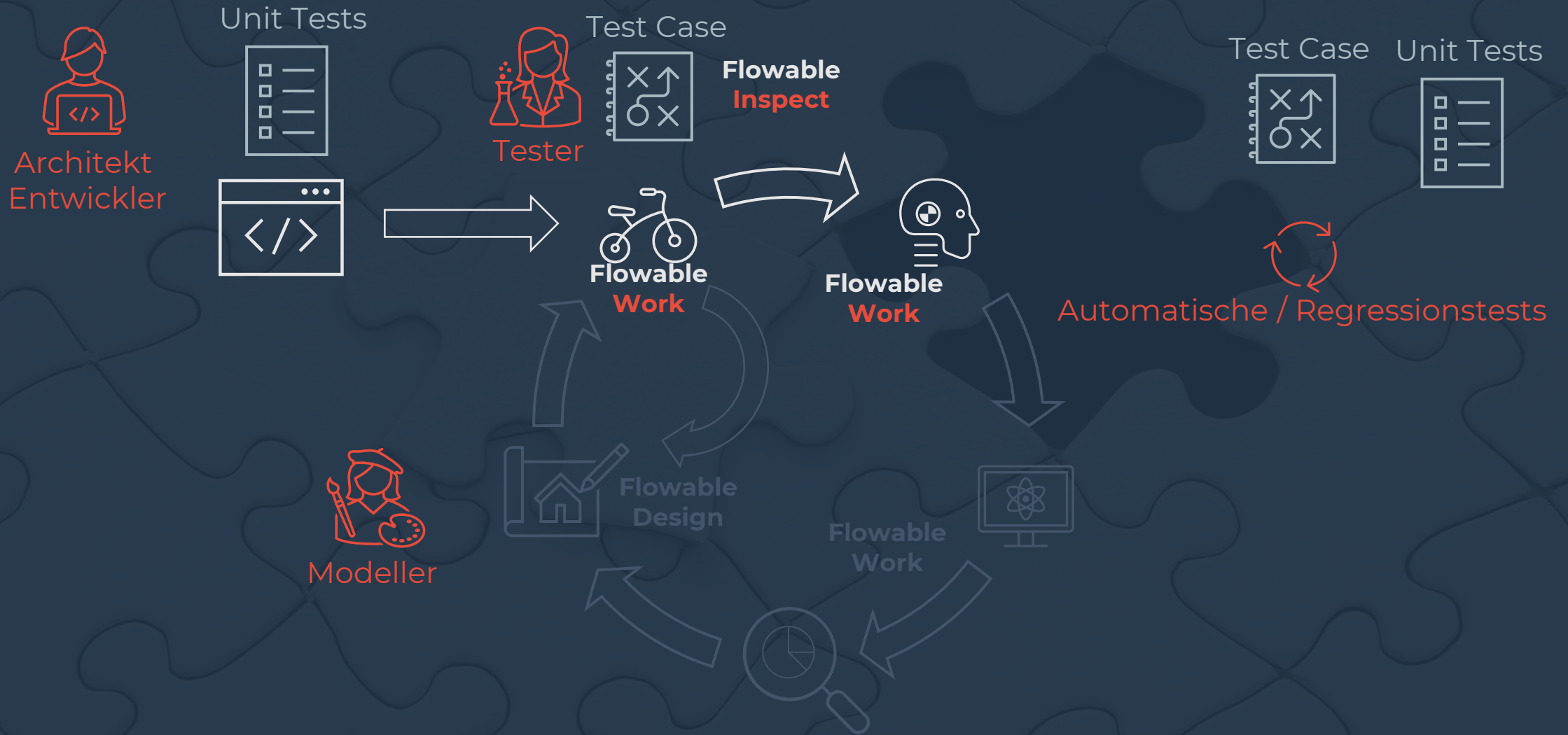

Flowable Testing

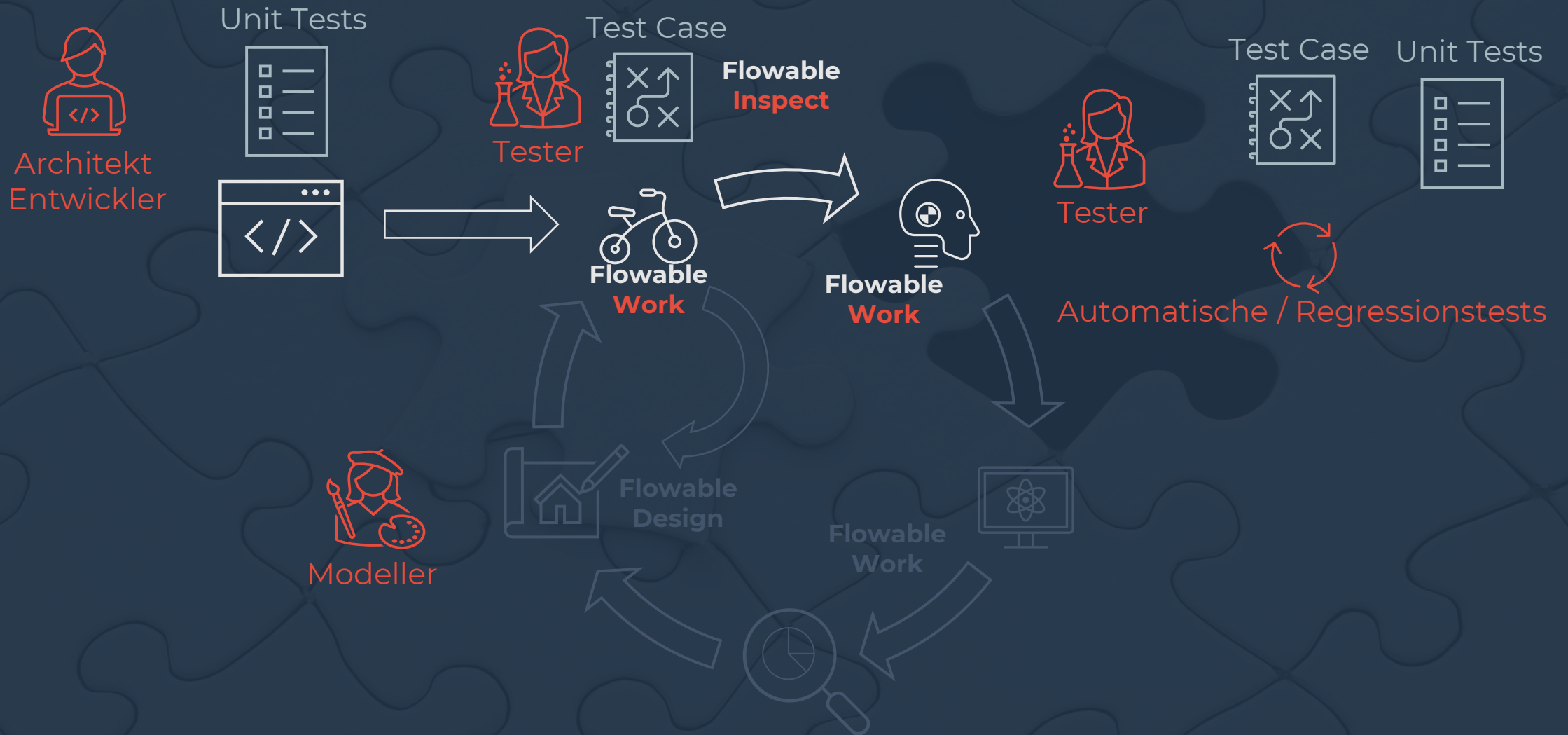

THE PLATFORM

Flowable Work

Intelligent Business Automation

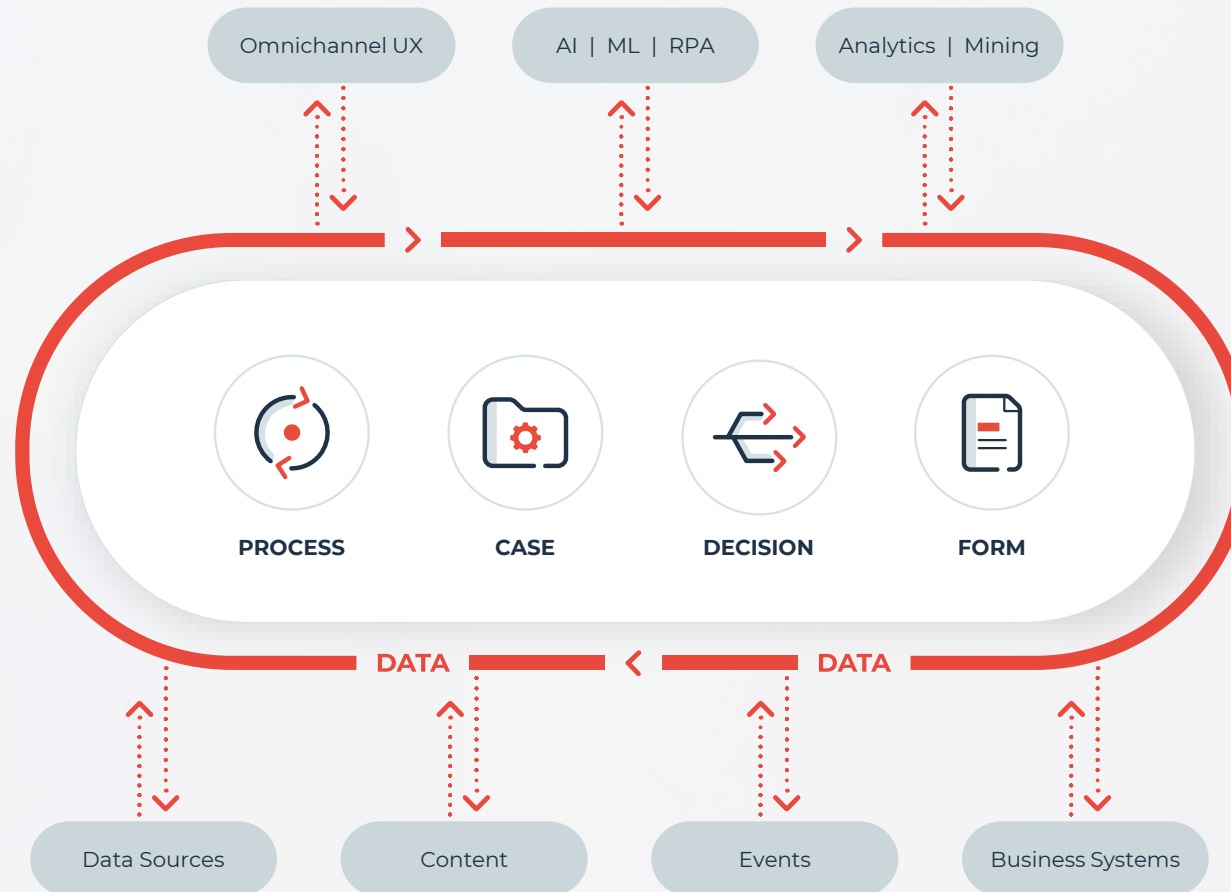



Matúš Mala
Tech Lead
Flowable Deutschland



<https://de.linkedin.com/in/matusmala>



<https://twitter.com/matusmala>

**THANK
YOU!**